

- COPYRIGHT IS NOT RESERVED BY AUTHORS.
- AUTHORS ARE NOT RESPONSIBLE FOR ANY LEGAL ISSUES ARISING OUT OF ANY COPYRIGHT DEMANDS
- AND/OR REPRINT ISSUES CONTAINED IN THIS MATERIALS.
- THIS IS NOT MEANT FOR ANY COMMERCIAL PURPOSE & ONLY MEANT FOR PERSONAL USE OF STUDENTS FOLLOWING SYLLABUS PRINTED NEXT PAGE.
- READERS ARE REQUESTED TO SEND ANY TYPING ERRORS CONTAINED, HEREIN.

**Lecture Notes**  
**On**  
**Electromagnetic Field Theory**

## **ELECTROMAGNETIC FIELD THEORY (3-1-0)**

### **Module-I**

**(12 Hours)**

The Co-ordinate Systems, Rectangular, Cylindrical, and Spherical Co-ordinate System. Co-ordinate transformation. Gradient of a Scalar field, Divergence of a vector field and curl of a vector field. Their Physical interpretation. The Laplacian. Divergence Theorem, Stokes Theorem. Useful vector identities. Electrostatics: The experimental law of Coulomb, Electric field intensity. Field due to a line charge, Sheetcharge and continuous volume charge distribution. Electric Flux and flux density; Gauss's law. Application of Gauss's law. Energy and Potential. The Potential Gradient. The Electric dipole. The Equipotential surfaces. Energy stored in an electrostatic field. Boundary conditions. Capacitors and Capacitances. Poisson's and Laplace's equations. Solutions of simple boundary value problems. Method of Images.

### **Module-II**

**(10 Hours)**

Steady Electric Currents: Current densities, Resistances of a Conductor; The equation of continuity. Joules law. Boundary conditions for Current densities. The EMF. Magnetostatics: The Biot-Savart law. Amperes Force law. Torque exerted on a current carrying loop by a magnetic field. Gauss's law for magnetic fields. Magnetic vector potential. Magnetic Field Intensity and Ampere's Circuital law. Boundary conditions. Magnetic Materials. Energy in magnetic field. Magnetic circuits.

### **Module-III**

**(12 Hours)**

Faraday's law of Induction; Self and Mutual Induction. Maxwell's Equations from Ampere's and Gauss's Laws. Maxwell's Equations in Differential and Integral forms; Equation of continuity. Concept of Displacement Current. Electromagnetic Boundary Conditions, Poynting's Theorem, Time-Harmonic EM Fields. Plane Wave Propagation: Helmholtz wave equation. Plane wave solution. Plane Wave Propagation in lossless and lossy dielectric medium and conducting medium. Plane wave in good conductor, Surface resistance, depth of penetration. Polarization of EM wave- Linear, Circular and Elliptical polarization. Normal and Oblique incidence of linearly polarized wave at the plane boundary of a perfect conductor, Dielectric-Dielectric Interface. Reflection and Transmission Co-efficient for parallel and perpendicular polarization, Brewster angle.

### **Module-IV**

**(8 Hours)**

Radio Wave Propagation: Modes of propagation, Structure of Troposphere, Tropospheric Scattering, Ionosphere, Ionospheric Layers - D, E, F1, F2, regions. Sky wave propagation - propagation of radio waves through Ionosphere, Effect of earth's magnetic field, Virtual height, Skip Distance, MUF, Critical frequency, Space wave propagation.

## MODULE-I

### STATICELECTRIC FIELD:

Electromagnetic theory is a discipline concerned with the study of charges at rest and in motion. Electromagnetic principles are fundamental to the study of electrical engineering and physics. Electromagnetic theory is also indispensable to the understanding, analysis and design of various electrical, electromechanical and electronic systems. Some of the branches of study where electromagnetic principles find application are: RF communication, Microwave Engineering, Antennas, Electrical Machines, Satellite Communication, Atomic and nuclear research ,Radar Technology, Remote sensing, EMI EMC, Quantum Electronics, VLSI .Electromagnetic theory is a prerequisite for a wide spectrum of studies in the field of Electrical Sciences and Physics. Electromagnetic theory can be thought of as generalization of circuit theory. There are certain situations that can be handled exclusively in terms of field theory. In electromagnetic theory, the quantities involved can be categorized as source quantities and field quantities. Source of electromagnetic field is electric charges: either at rest or in motion. However an electromagnetic field may cause a redistribution of charges that in turn change the field and hence the separation of cause and effect is not always visible.

#### *Sources of EMF:*

- Current carrying conductors.
- Mobile phones.
- Microwave oven.
- Computer and Television screen.
- High voltage Power lines.

#### *Effects of Electromagnetic fields:*

- Plants and Animals.
- Humans.
- Electrical components.

*Fields are classified as*

- Scalar field
- Vector field.

Electric charge is a fundamental property of matter. Charge exist only in positive or negative integral multiple of electronic charge,  $e = 1.60 \times 10^{-19}$  coulombs. [It may be noted here that in 1962, Murray Gell-Mann hypothesized Quarks as the basic building blocks of matters. Quarks were predicted to carry a fraction of electronic charge and the existence of Quarks has been experimentally verified.] Principle of conservation of charge states that the total charge (algebraic sum of positive and negative charges) of an isolated system remains unchanged, though the charges may redistribute under the influence of electric field. Kirchhoff's Current Law (KCL) is an assertion of the conservative property of charges under the implicit assumption that there is no accumulation of charge at the junction. Electromagnetic theory deals directly with the electric and magnetic field vectors where as circuit theory deals with the voltages and currents. Voltages and currents are integrated effects of electric and magnetic fields respectively. Electromagnetic field problems involve three space variables along with the time variable and hence the solution tends to become correspondingly complex. Vector analysis is a mathematical tool with which electromagnetic concepts are more conveniently expressed and best comprehended. Since use of vector analysis in the study of electromagnetic field theory results in real economy of time and thought, we first introduce the concept of vector analysis.

**Vector Analysis:**

The quantities that we deal in electromagnetic theory may be either scalar or vectors. There is other class of physical quantities called Tensors: where magnitude and direction vary with coordinate axes]. Scalars are quantities characterized by magnitude only and algebraic sign. A quantity that has direction as well as magnitude is called a vector. Both scalar and vector quantities are function of *time* and *position*. A field is a function that specifies a particular quantity everywhere in a region. Depending upon the nature of the quantity under consideration, the field may be a vector or a scalar field. Example of scalar field is the electric potential in a region while electric or magnetic fields at any point is the example of vector field.

A vector can be written as, where, is the magnitude and is the unit vector which has unit magnitude and same direction as that of .Two vector and are added together to give another

vector . We have  $\vec{C} = \vec{A} + \vec{B}$  Let us see the animations in the next pages for the addition of two vectors, which has two 1. parallelogram law, 2. Head & Tail rule

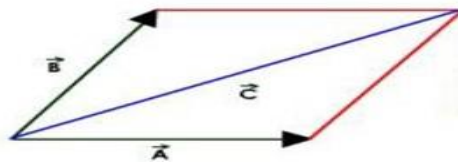

PARALLELOGRAM RULE FOR VECTOR ADDITION  
 USE THE PLAY AND STOP BUTTONS TO VIEW HOW THE  
 VECTORS A AND B ARE ADDED AND THE RESULTANT C IS  
 PRODUCED

Fig 1.1(a): Vector Addition (Parallelogram Rule)

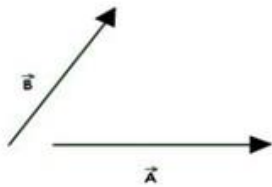

HEAD TO TAIL RULE FOR VECTOR ADDITION  
 USE THE PLAY AND STOP BUTTONS TO VIEW HOW THE  
 VECTORS A AND B ARE ADDED AND THE RESULTANT C IS  
 PRODUCED

Fig 1.1(b): Vector Addition (Head & Tail Rule)

## VECTOR ADDITION

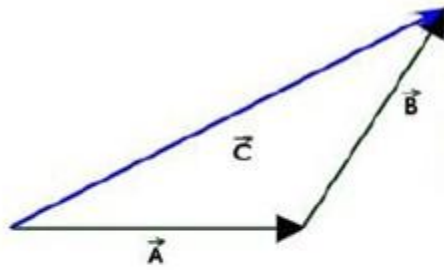

HEAD TO TAIL RULE FOR VECTOR ADDITION  
USE THE **PLAY** AND **STOP** BUTTONS TO VIEW HOW THE  
VECTORS A AND B ARE ADDED AND THE RESULTANT C IS  
PRODUCED

Fig 1.1(b): Vector Addition (Head & Tail Rule)

## VECTOR SUBTRACTION

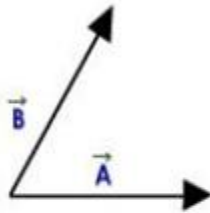

CLICK **PLAY** AND **STOP** TO SEE THE VECTOR SUBTRACTION  
OF A AND B

Fig 1.2: Vector subtraction

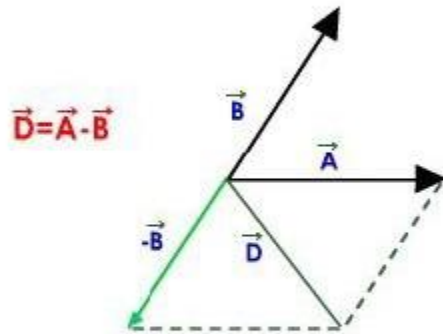

CLICK **PLAY** AND **STOP** TO SEE THE VECTOR SUBTRATION  
OF A AND B

Fig 1.2: Vector subtraction

Scaling of a vector is defined as, where is scaled version of vector and is a scalar.

Some important laws of vector algebra are: commutative Law Associative Law Distributive Law

$$\vec{A} + \vec{B} = \vec{B} + \vec{A}$$

$$\vec{A} + (\vec{B} + \vec{C}) = (\vec{A} + \vec{B}) + \vec{C}$$

$$\alpha(\vec{A} + \vec{B}) = \alpha\vec{A} + \alpha\vec{B}$$

The position vector of a point  $P$  is the directed distance from the origin ( $O$ ) to  $P$ .

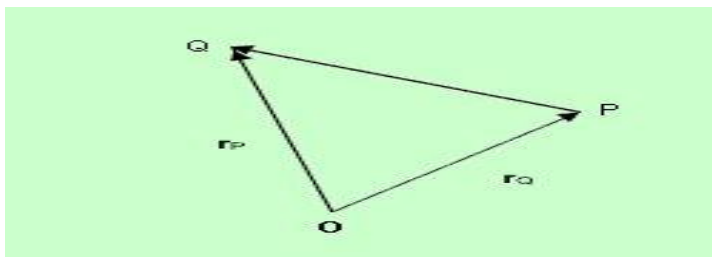

Fig 1.3 Distance Vector



If  $\vec{r}_P = \vec{OP}$  and  $\vec{r}_Q = \vec{OQ}$  are the position vectors of the points P and Q then the distance vector

$$\vec{PQ} = \vec{OQ} - \vec{OP} = \vec{r}_Q - \vec{r}_P$$

### PRODUCT OF VECTOR:

When two vectors are multiplied, the result is either a scalar or a vector depending how the two vectors were multiplied. The two types of vector multiplication are:

Scalar product (or dot product) gives a scalar.

Vector product (or cross product) gives a vector.

The dot product between two vectors is defined as  $= |A||B|\cos\theta_{AB}$

Vector product  $\vec{A} \times \vec{B} = |A||B|\sin\theta_{AB} \cdot \vec{n}$   
 $\vec{n}$  is unit vector perpendicular to  $\vec{A}$  and  $\vec{B}$

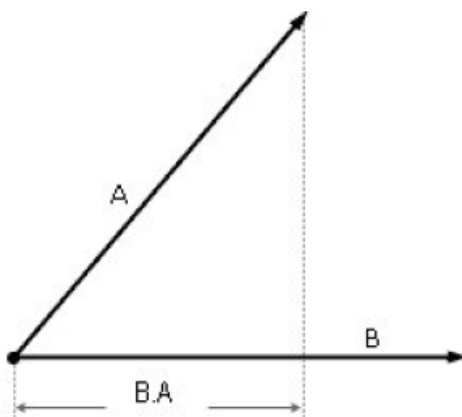

**Fig 1.4: Vector dot product**

The dot product is commutative i.e.,  $\vec{A} \cdot \vec{B} = \vec{B} \cdot \vec{A}$  and distributive i.e.,

$$\vec{A} \cdot (\vec{B} + \vec{C}) = \vec{A} \cdot \vec{B} + \vec{A} \cdot \vec{C}$$

. Associative law does not apply to scalar product.

The vector or cross product of two vectors  $\vec{A}$  and  $\vec{B}$  is denoted by  $\vec{A} \times \vec{B}$ .  $\vec{A} \times \vec{B}$  is a vector perpendicular to the plane containing  $\vec{A}$  and  $\vec{B}$ , the magnitude is given by  $|A||B|\sin\theta_{AB}$  and direction is given by right hand rule as explained in Figure 1.5.

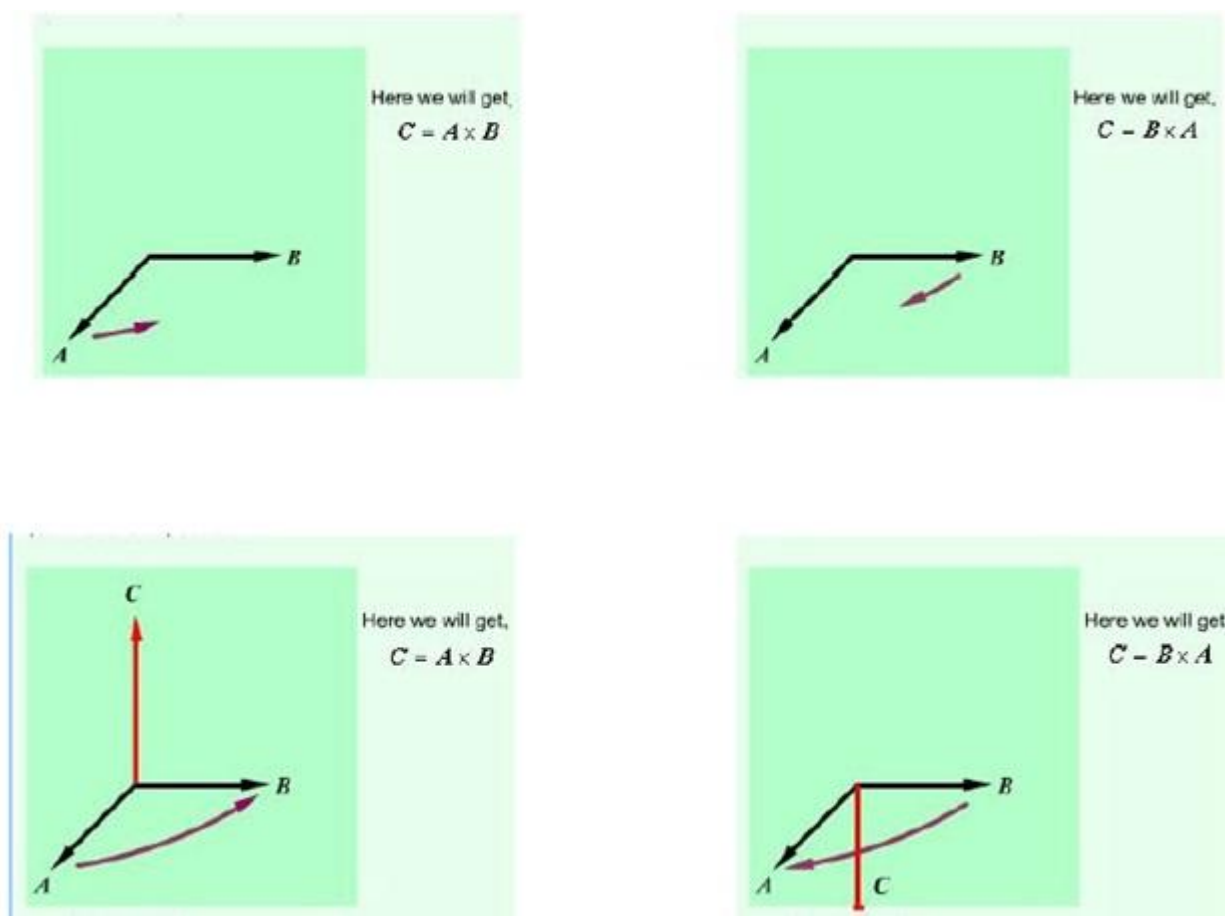

Fig 1.5

$$\vec{A} \times \vec{B} = \hat{a}_n AB \sin \theta_{AB} \dots\dots\dots (1.7)$$

where  $\hat{a}_n$  is the unit vector given by,  $\hat{a}_n = \frac{\vec{A} \times \vec{B}}{|\vec{A} \times \vec{B}|}$ .

The following relations hold for vector product.

$$\vec{A} \times \vec{B} = -\vec{B} \times \vec{A} \quad \text{i.e., cross product is non commutative} \dots\dots\dots (1.8)$$

$$\vec{A} \times (\vec{B} + \vec{C}) = \vec{A} \times \vec{B} + \vec{A} \times \vec{C} \quad \text{i.e., cross product is distributive} \dots\dots\dots (1.9)$$

$$\vec{A} \times (\vec{B} \times \vec{C}) \neq (\vec{A} \times \vec{B}) \times \vec{C} \quad \text{i.e., cross product is non associative} \dots\dots\dots (1.10)$$

**Scalar and vector triple product :**

Scalar triple product  $\vec{A} \cdot (\vec{B} \times \vec{C}) = \vec{B} \cdot (\vec{C} \times \vec{A}) = \vec{C} \cdot (\vec{A} \times \vec{B}) \dots\dots\dots(1.11)$

Vector triple product  $\vec{A} \times (\vec{B} \times \vec{C}) = \vec{B} (\vec{A} \cdot \vec{C}) - \vec{C} (\vec{A} \cdot \vec{B}) \dots\dots\dots(1.12)$

**Co-ordinate Systems**

In order to describe the spatial variations of the quantities, we require using appropriate co-ordinate system. A point or vector can be represented in a curvilinear coordinate system that may be orthogonal or non-orthogonal .An orthogonal system is one in which the co-ordinates are mutually perpendicular. No orthogonal co-ordinate systems are also possible, but their usage is very limited in practice .Let  $u = \text{constant}$ ,  $v = \text{constant}$  and  $w = \text{constant}$  represent surfaces in a coordinate system, the surfaces may be curved surfaces in general. Further, let  $\hat{a}_u$ ,  $\hat{a}_v$  and  $\hat{a}_w$  be the unit vectors in the three coordinate directions(base vectors). In general right handed orthogonal curvilinear systems, the vectors satisfy the following relations:

$$\begin{aligned} \hat{a}_u \times \hat{a}_v &= \hat{a}_w \\ \hat{a}_v \times \hat{a}_w &= \hat{a}_u \\ \hat{a}_w \times \hat{a}_u &= \hat{a}_v \end{aligned}$$

These equations are not independent and specification of one will automatically imply the other two. Furthermore, the following relations hold

$$\begin{aligned} \hat{a}_u \cdot \hat{a}_v &= \hat{a}_v \cdot \hat{a}_w = \hat{a}_w \cdot \hat{a}_u = 0 \\ \hat{a}_u \cdot \hat{a}_u &= \hat{a}_v \cdot \hat{a}_v = \hat{a}_w \cdot \hat{a}_w = 1 \dots\dots\dots(1.14) \end{aligned}$$

In the following sections we discuss three most commonly used orthogonal coordinate Systems.

1. Cartesian (or rectangular) co-ordinate system
2. Cylindrical co-ordinate system
3. Spherical polar co-ordinate system

### Cartesian Co-ordinate System:

In Cartesian co-ordinate system, we have,  $(u, v, w) = (x, y, z)$ . A point  $P(x_0, y_0, z_0)$  in Cartesian co-ordinate system is represented as intersection of three planes  $x = x_0$ ,  $y = y_0$  and  $z = z_0$ . The unit vectors satisfy the following relation:

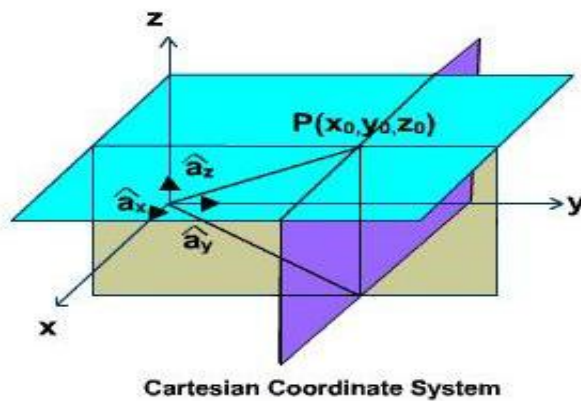

Fig 1.7: Cartesian Co-ordinate System

$$\hat{a}_x \times \hat{a}_y = \hat{a}_z$$

$$\hat{a}_y \times \hat{a}_z = \hat{a}_x$$

$$\hat{a}_z \times \hat{a}_x = \hat{a}_y$$

$$\hat{a}_x \cdot \hat{a}_y = \hat{a}_y \cdot \hat{a}_z = \hat{a}_z \cdot \hat{a}_x = 0$$

$$\hat{a}_x \cdot \hat{a}_x = \hat{a}_y \cdot \hat{a}_y = \hat{a}_z \cdot \hat{a}_z = 1$$

$$\vec{OP} = \hat{a}_x x_0 + \hat{a}_y y_0 + \hat{a}_z z_0$$

In cartesian co-ordinate system, a vector  $\vec{A}$  can be written as  $\vec{A} = \hat{a}_x A_x + \hat{a}_y A_y + \hat{a}_z A_z$ .

The dot and cross product of two vectors  $\vec{A}$  and  $\vec{B}$  can be written as follows:

$$\vec{A} \cdot \vec{B} = A_x B_x + A_y B_y + A_z B_z \quad \dots\dots\dots(1.19)$$

$$\vec{A} \times \vec{B} = \hat{a}_x (A_y B_z - A_z B_y) + \hat{a}_y (A_z B_x - A_x B_z) + \hat{a}_z (A_x B_y - A_y B_x)$$

$$= \begin{vmatrix} \hat{a}_x & \hat{a}_y & \hat{a}_z \\ A_x & A_y & A_z \\ B_x & B_y & B_z \end{vmatrix}$$

$$\dots\dots\dots(1.20)$$

Since  $x, y$  and  $z$  all represent lengths,  $h_1 = h_2 = h_3 = 1$ . The differential length, area and volume are defined respectively as

$$d\vec{l} = dx \hat{a}_x + dy \hat{a}_y + dz \hat{a}_z \quad \dots\dots\dots(1.21)$$

$$d\vec{s}_x = dydz \hat{a}_x$$

$$d\vec{s}_y = dx dz \hat{a}_y$$

$$d\vec{s}_z = dx dy \hat{a}_z$$

$$dV = dx dy dz \quad \dots\dots\dots(1.22)$$

Cylindrical Co-ordinate System:

For cylindrical coordinate systems we have  $(u, v, w) = (r, \phi, z)$  a point  $P(r_0, \phi_0, z_0)$  is determined as the point of intersection of a cylindrical surface  $r = r_0$  half plane

containing the z-axis and making an angle  $\phi$  ; with the xz plane and a plane parallel to xy plane located at  $z=z_0$  as shown in figure 7 on next page.

In cylindrical coordinate system, the unit vectors satisfy the following relations

A vector  $\vec{A}$  can be written as ,  $\vec{A} = A_\rho \hat{a}_\rho + A_\phi \hat{a}_\phi + A_z \hat{a}_z$  .....(1.24)

The differential length is defined as,

$$d\vec{l} = \hat{a}_\rho d\rho + \rho d\phi \hat{a}_\phi + dz \hat{a}_z \quad h_1 = 1, h_2 = \rho, h_3 = 1 \quad \text{.....(1.25)}$$

$$\hat{a}_\rho \times \hat{a}_\phi = \hat{a}_z$$

$$\hat{a}_\phi \times \hat{a}_z = \hat{a}_\rho$$

$$\hat{a}_z \times \hat{a}_\rho = \hat{a}_\phi \quad \text{.....(1.23)}$$

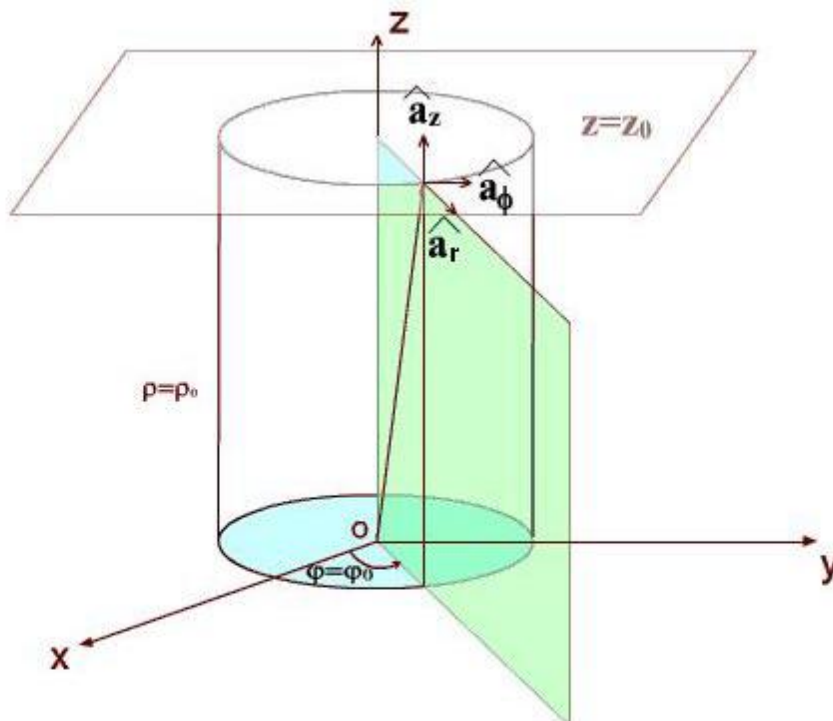

Fig 1.7 : Cylindrical Coordinate System

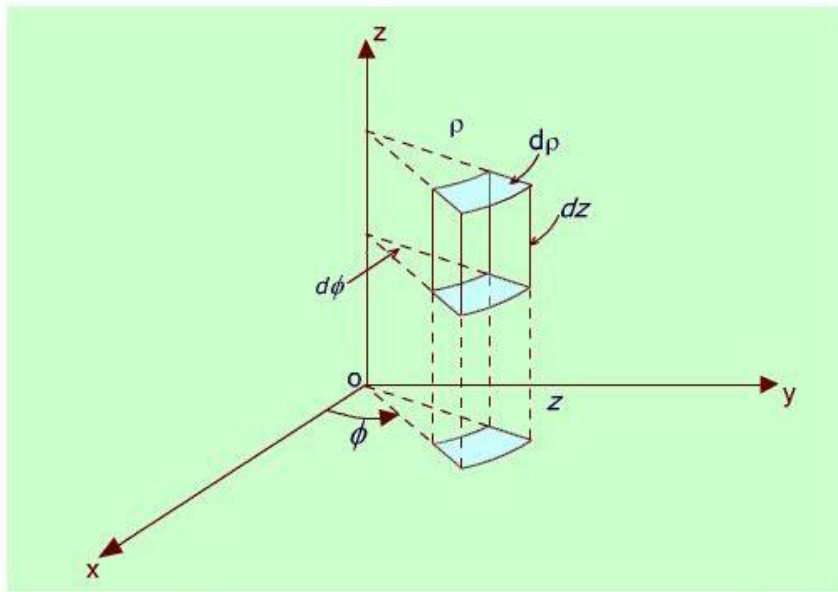

Fig 1.8 : Differential Volume Element in Cylindrical Coordinates

Differential areas are:

$$\vec{ds}_\rho = \rho d\phi dz \hat{a}_\rho$$

$$\vec{ds}_\phi = d\rho dz \hat{a}_\phi \dots\dots\dots(1.26)$$

$$\vec{ds}_z = \rho d\phi d\rho \hat{a}_z$$

Differential volume,

$$dv = \rho d\rho d\phi dz \dots\dots\dots(1.27)$$

Let us consider  $\vec{A} = \hat{a}_\rho A_\rho + \hat{a}_\phi A_\phi + \hat{a}_z A_z$  is to be expressed in Cartesian co-ordinate as

$$\vec{A} = \hat{a}_x A_x + \hat{a}_y A_y + \hat{a}_z A_z \quad A_x = \vec{A} \cdot \hat{a}_x = \left( \hat{a}_\rho A_\rho + \hat{a}_\phi A_\phi + \hat{a}_z A_z \right) \cdot \hat{a}_x$$

and it applies for other components as well.

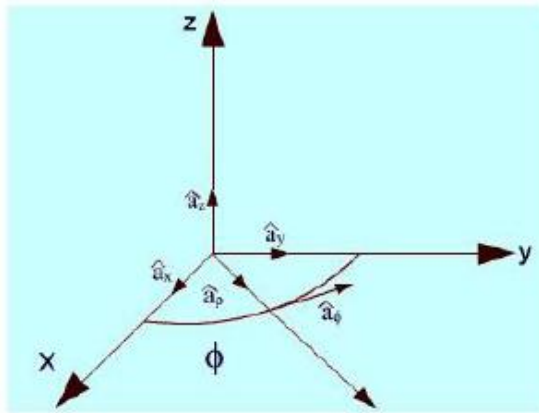

Fig 1.9 : Unit Vectors in Cartesian and Cylindrical Coordinates

$$\begin{aligned} \hat{a}_\rho \cdot \hat{a}_x &= \cos \phi \\ \hat{a}_\rho \cdot \hat{a}_y &= \sin \phi \\ \hat{a}_\phi \cdot \hat{a}_x &= \cos(\phi + \frac{\pi}{2}) = -\sin \phi \end{aligned} \dots\dots\dots(1.28)$$

$$\begin{aligned} \hat{a}_\phi \cdot \hat{a}_y &= \cos \phi \\ \text{Therefore we can write,} \\ A_x &= \vec{A} \cdot \hat{a}_x = A_\rho \cos \phi - A_\phi \sin \phi \\ A_y &= \vec{A} \cdot \hat{a}_y = A_\rho \sin \phi + A_\phi \cos \phi \dots\dots\dots(1.29) \\ A_z &= \vec{A} \cdot \hat{a}_z = A_z \end{aligned}$$

These relations can be put conveniently in the matrix form as:

$$\begin{bmatrix} A_x \\ A_y \\ A_z \end{bmatrix} = \begin{bmatrix} \cos \phi & -\sin \phi & 0 \\ \sin \phi & \cos \phi & 0 \\ 0 & 0 & 1 \end{bmatrix} \begin{bmatrix} A_\rho \\ A_\phi \\ A_z \end{bmatrix} \dots\dots\dots(1.30)$$

$A_\rho, A_\phi$  and  $A_z$  themselves may be functions of  $\rho, \phi$  and  $z$  as:

$$\begin{aligned} x &= \rho \cos \phi \\ y &= \rho \sin \phi \\ z &= z \end{aligned} \dots\dots\dots(1.31)$$



$A_\rho, A_\phi$  and  $A_z$  themselves may be functions of  $\rho, \phi$  and  $z$  as:

$$\begin{aligned} x &= \rho \cos \phi \\ y &= \rho \sin \phi \\ z &= z \end{aligned} \quad \dots\dots\dots(1.31)$$

$$\rho = \sqrt{x^2 + y^2}$$

$$\phi = \tan^{-1} \frac{y}{x}$$

The inverse relationships are:  $z = z \quad \dots\dots\dots(1.32)$

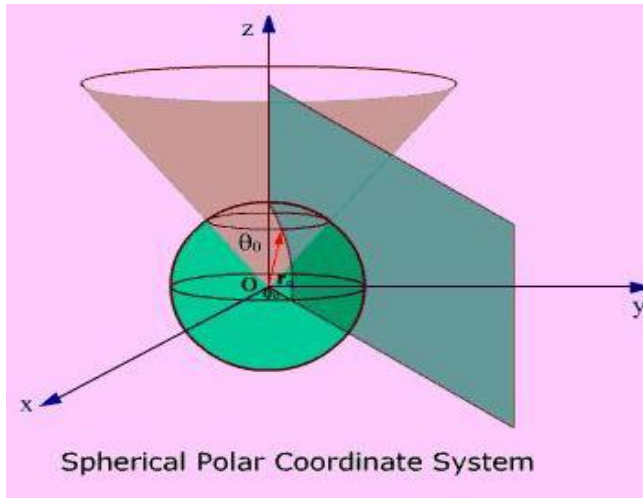

Fig 1.10

Thus we see that a vector in one coordinate system is transformed to another coordinate system through two-step process: Finding the component vectors and then variable transformation.

Spherical Polar Coordinates:

For spherical polar coordinate system, we have,  $(u, v, w) = (r, \theta, \phi)$ . A point  $P(r_0, \theta_0, \phi_0)$  is represented as the intersection of

(i) Spherical surface  $r=r_0$

(ii) Conical surface  $\theta = \theta_0$ , and

(iii) half plane containing z-axis making angle  $\phi = \phi_0$  with the xz plane as shown in the figure 1.10.

$$\hat{a}_r \times \hat{a}_\theta = \hat{a}_\phi$$

$$\hat{a}_\theta \times \hat{a}_\phi = \hat{a}_r$$

$$\hat{a}_\phi \times \hat{a}_r = \hat{a}_\theta$$

The unit vectors satisfy the following relationships:  
 .....(1.33)

The orientation of the unit vectors are shown in the figure 1.11.

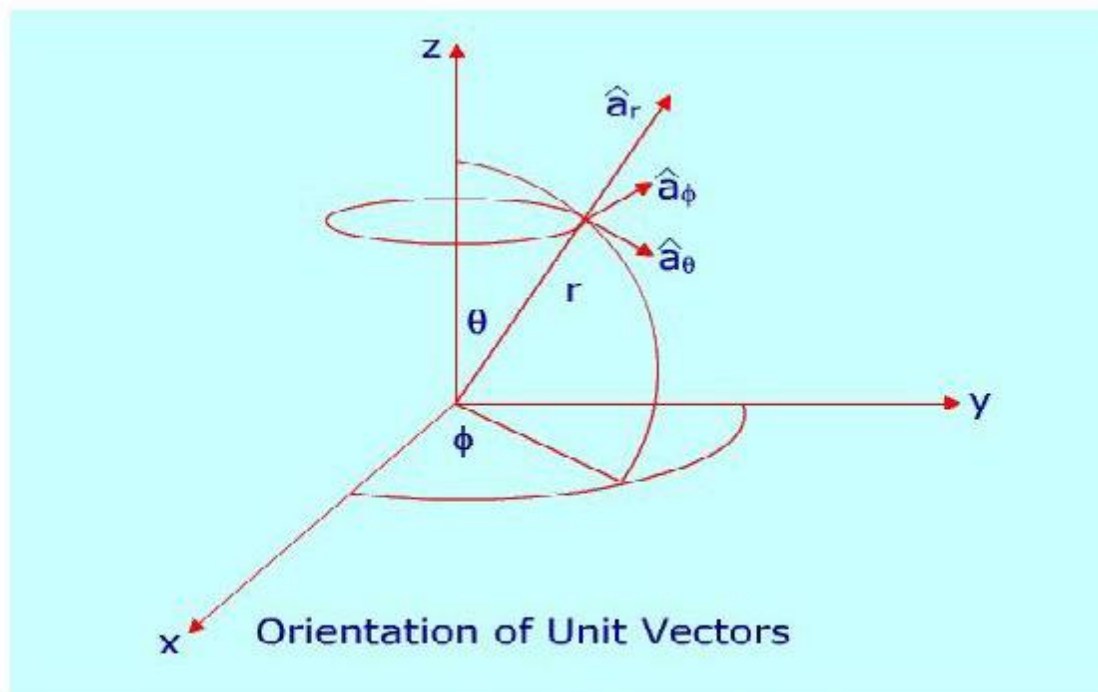

Fig 1.11: Orientation of Unit Vectors

A vector in spherical polar co-ordinates is written as :  $\vec{A} = A_r \hat{a}_r + A_\theta \hat{a}_\theta + A_\phi \hat{a}_\phi$  and

$$d\vec{l} = \hat{a}_r dr + \hat{a}_\theta r d\theta + \hat{a}_\phi r \sin \theta d\phi$$

For spherical polar coordinate system we have  $h_1=1$ ,  $h_2=r$  and  $h_3= r \sin \theta$ .

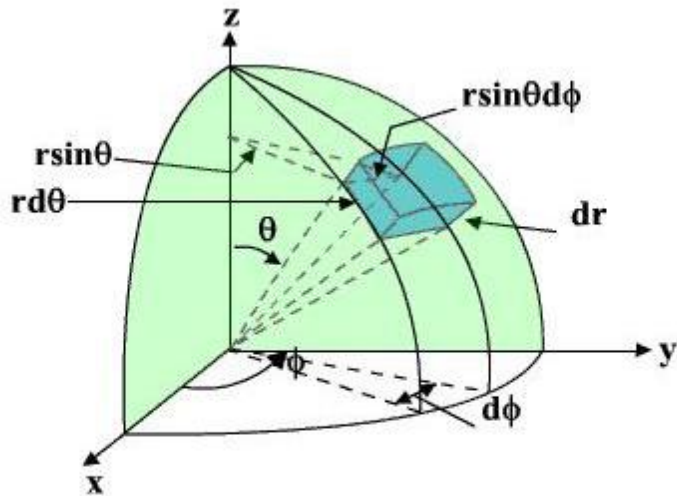
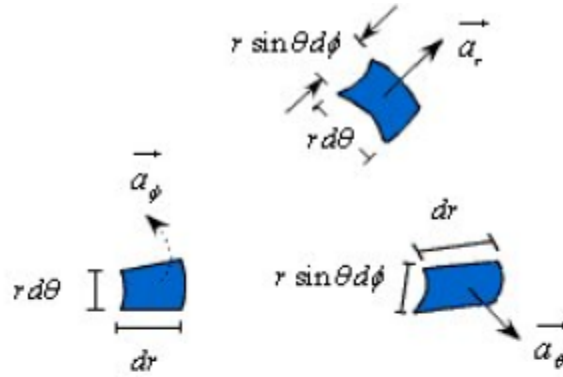

Fig 1.12(a) : Differential volume in s-p coordinates



**Fig 1.12(b) : Exploded view**

With reference to the Figure 1.12, the elemental areas are:

$$\begin{aligned}
 ds_r &= r^2 \sin \theta d\theta d\phi \hat{a}_r \\
 ds_\theta &= r \sin \theta dr d\phi \hat{a}_\theta \\
 ds_\phi &= r dr d\theta \hat{a}_\phi \quad \dots\dots\dots(1.34)
 \end{aligned}$$

and elementary volume is given by

$$dV = r^2 \sin \theta dr d\theta d\phi \quad \dots\dots\dots(1.35)$$

Coordinate transformation between rectangular and spherical polar:

We can write

$$\hat{a}_r \cdot \hat{a}_x = \sin \theta \cos \phi$$

$$\hat{a}_r \cdot \hat{a}_y = \sin \theta \sin \phi$$

$$\hat{a}_r \cdot \hat{a}_z = \cos \theta$$

$$\hat{a}_\theta \cdot \hat{a}_x = \cos \theta \cos \phi$$

$$\hat{a}_\theta \cdot \hat{a}_y = \cos \theta \sin \phi$$

$$\hat{a}_\theta \cdot \hat{a}_z = \cos(\theta + \frac{\pi}{2}) = -\sin \theta$$

$$\hat{a}_\phi \cdot \hat{a}_x = \cos(\phi + \frac{\pi}{2}) = -\sin \phi$$

$$\hat{a}_\phi \cdot \hat{a}_y = \cos \phi$$

$$\hat{a}_\phi \cdot \hat{a}_z = 0$$

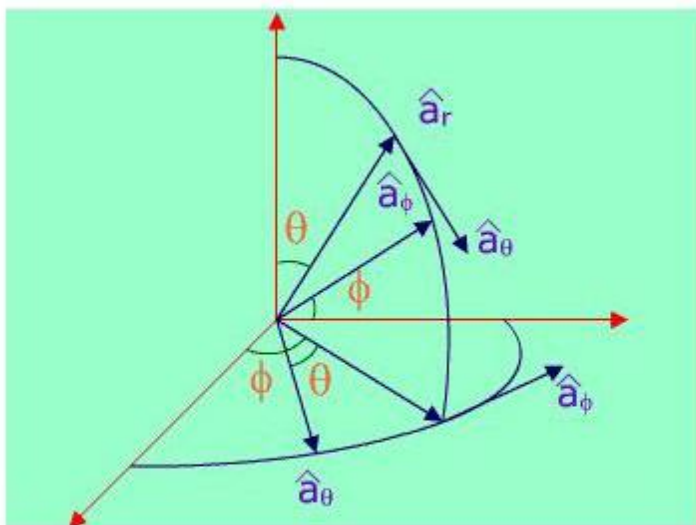

Fig 1.13: Coordinate transformation

$$\begin{bmatrix} A_x \\ A_y \\ A_z \end{bmatrix} = \begin{bmatrix} \sin \theta \cos \phi & \cos \theta \cos \phi & -\sin \phi \\ \sin \theta \sin \phi & \cos \theta \sin \phi & \cos \phi \\ \cos \theta & -\sin \theta & 0 \end{bmatrix} \begin{bmatrix} A_r \\ A_\theta \\ A_\phi \end{bmatrix} \dots\dots\dots(1.39)$$

The components  $A_r, A_\theta$  and  $A_\phi$  themselves will be functions of  $r, \theta$  and  $\phi$ .  $r, \theta$  and  $\phi$  are related to  $x, y$  and  $z$  as:

$$\begin{aligned} x &= r \sin \theta \cos \phi \\ y &= r \sin \theta \sin \phi \\ z &= r \cos \theta \end{aligned} \dots\dots\dots(1.40)$$

and conversely,

$$r = \sqrt{x^2 + y^2 + z^2} \dots\dots\dots(1.41a)$$

$$\theta = \cos^{-1} \frac{z}{\sqrt{x^2 + y^2 + z^2}} \dots\dots\dots(1.41b)$$

$$\phi = \tan^{-1} \frac{y}{x} \dots\dots\dots(1.41c)$$

**Line Integral:** Line integral  $\int_C \vec{E} \cdot d\vec{l}$  is the dot product of a vector with a specified  $C$ ; in other words it is the integral of the tangential component  $\vec{E}$  along the curve  $C$ .

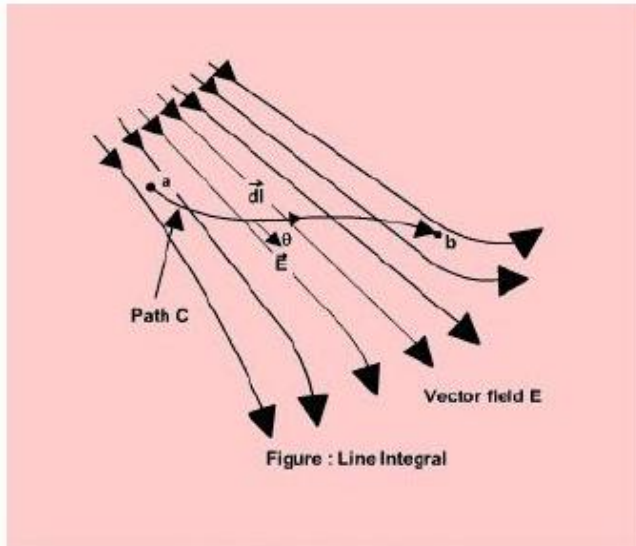

Fig 1.14: Line Integral

As shown in the figure 1.14, given a vector  $\vec{E}$  around  $C$ , we define the integral

$$\int_C \vec{E} \cdot d\vec{l} = \int_a^b E \cos \theta dl$$

as the line integral of  $E$  along the curve  $C$ .

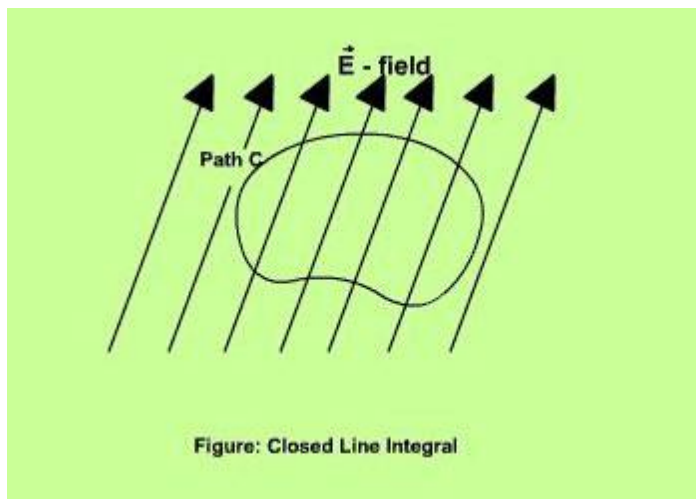

Fig 1.15: Closed Line Integral

### Surface Integral :

Given a vector field  $\vec{A}$ , continuous in a region containing the smooth surface  $S$ , we define the surface integral or the flux of  $\vec{A}$  through  $S$  as

$$\psi = \int_S A \cos \theta dS = \int_S \vec{A} \cdot \hat{a}_n dS = \int_S \vec{A} d\vec{S}$$

as surface integral over surface  $S$ .

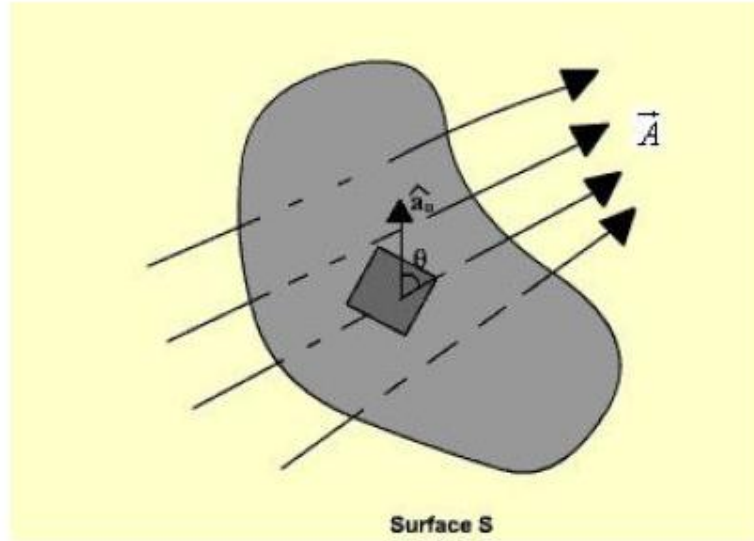

Fig 1.16 : Surface Integral

If the surface integral is carried out over a closed surface, then we write

$$\psi = \oint_S \vec{A} d\vec{S}$$



The Del Operator:

The vector differential operator was introduced by Sir W. R. Hamilton and later on developed by P. G. Tait. Mathematically the vector differential operator can be written in the general form as

$$\nabla = \frac{1}{h_1} \frac{\partial}{\partial u} \hat{a}_u + \frac{1}{h_2} \frac{\partial}{\partial v} \hat{a}_v + \frac{1}{h_3} \frac{\partial}{\partial w} \hat{a}_w \dots\dots\dots(1.43)$$

**Gradient of a Scalar function:**

In Cartesian coordinates:

$$\nabla = \frac{\partial}{\partial x} \hat{a}_x + \frac{\partial}{\partial y} \hat{a}_y + \frac{\partial}{\partial z} \hat{a}_z \dots\dots\dots(1.44)$$

In cylindrical coordinates:

$$\nabla = \frac{\partial}{\partial \rho} \hat{a}_\rho + \frac{1}{\rho} \frac{\partial}{\partial \phi} \hat{a}_\phi + \frac{\partial}{\partial z} \hat{a}_z \dots\dots\dots(1.45)$$

and in spherical polar coordinates:

$$\nabla = \frac{\partial}{\partial r} \hat{a}_r + \frac{1}{r} \frac{\partial}{\partial \theta} \hat{a}_\theta + \frac{1}{r \sin \theta} \frac{\partial}{\partial \phi} \hat{a}_\phi \dots\dots\dots(1.46)$$

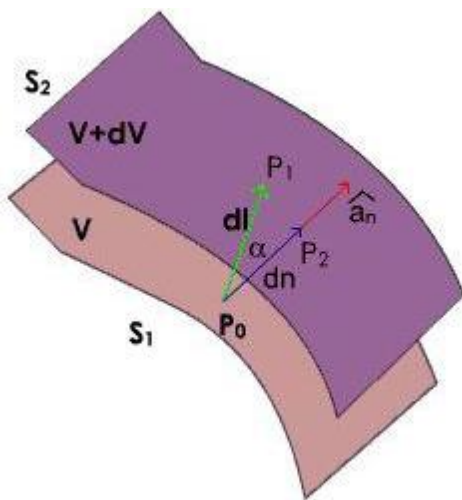

**Fig 1.17: Gradient of a scalar function**

**Divergence of a Vector Field:**

In study of vector fields, directed line segments, also called flux lines or streamlines, represent field variations graphically. The intensity of the field is proportional to the density of lines. For example, the number of flux lines passing through a unit surface  $S$  normal to the vector measures the vector field strength.

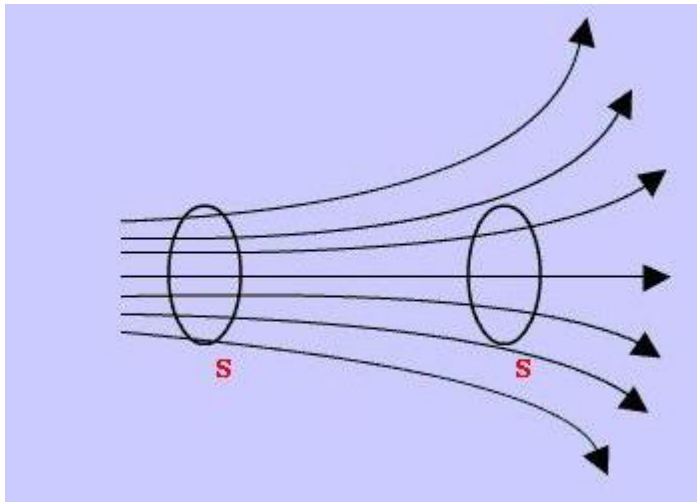

**Fig 1.18: Flux Lines**

We have already defined flux of a vector field as

$$\psi = \int_S A \cos \theta ds = \int_S \vec{A} \cdot \hat{a}_n ds = \int_S \vec{A} \cdot d\vec{s} \dots\dots\dots (1.57)$$

For a volume enclosed by a surface,

$$\psi = \oint_S \vec{A} \cdot d\vec{s} \dots\dots\dots (1.58)$$

We define the divergence of a vector field  $\vec{A}$  at a point  $P$  as the net outward flux from a volume enclosing  $P$ , as the volume shrinks to zero.

$$\operatorname{div} \vec{A} = \nabla \cdot \vec{A} = \lim_{\Delta V \rightarrow 0} \frac{\oint_S \vec{A} \cdot d\vec{s}}{\Delta V} \dots\dots\dots (1.59)$$

Here  $\Delta V$  is the volume that encloses  $P$  and  $S$  is the corresponding closed surface.

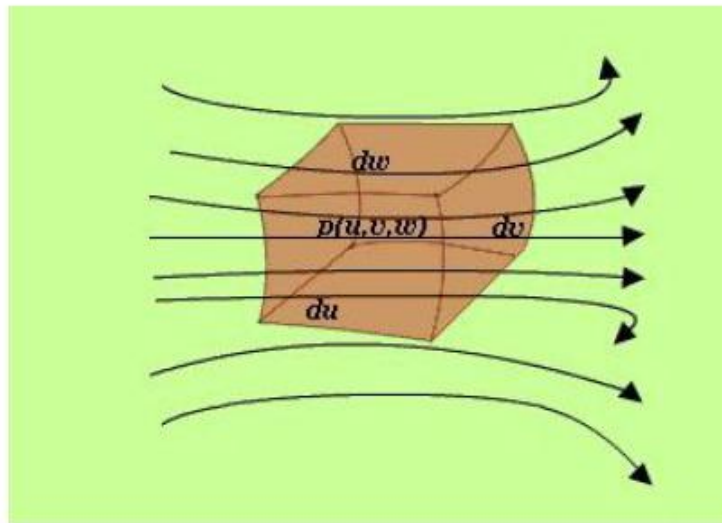

**Fig 1.19: Evaluation of divergence in curvilinear coordinate**

Let us consider a differential volume centered on point  $P(u, v, w)$  in a vector field  $\vec{A}$ . The flux through an elementary area normal to  $u$  is given by ,

$$\phi_u = \vec{A} \cdot \hat{a}_u h_2 h_3 dv dw \dots\dots\dots (1.60)$$

Net outward flux along  $u$  can be calculated considering the two elementary surfaces perpendicular to  $u$

$$\left[ h_2 h_3 A_u \Big|_{\left(u+\frac{du}{2}, v, w\right)} - h_2 h_3 A_u \Big|_{\left(u-\frac{du}{2}, v, w\right)} \right] dv dw \cong \frac{\partial (h_2 h_3 A_u)}{\partial u} du dv dw \dots\dots\dots (1.61)$$

Considering the contribution from all six surfaces that enclose the volume, we can write

27

$$\text{div } \vec{A} = \nabla \cdot \vec{A} = \lim_{\Delta v \rightarrow 0} \frac{\oint_S \vec{A} \cdot d\vec{s}}{\Delta v} = \frac{du dv dw \frac{\partial(h_2 h_3 A_u)}{\partial u} + du dv dw \frac{\partial(h_1 h_3 A_v)}{\partial v} + du dv dw \frac{\partial(h_1 h_2 A_w)}{\partial w}}{h_1 h_2 h_3 du dv dw}$$

$$\therefore \nabla \cdot \vec{A} = \frac{1}{h_1 h_2 h_3} \left[ \frac{\partial(h_2 h_3 A_u)}{\partial u} + \frac{\partial(h_1 h_3 A_v)}{\partial v} + \frac{\partial(h_1 h_2 A_w)}{\partial w} \right] \dots\dots\dots(1.62)$$

Hence for the Cartesian, cylindrical and spherical polar coordinate system, the expressions for divergence written as:

**In Cartesian coordinates:**

$$\nabla \cdot \vec{A} = \frac{\partial A_x}{\partial x} + \frac{\partial A_y}{\partial y} + \frac{\partial A_z}{\partial z} \dots\dots\dots(1.63)$$

In cylindrical coordinates:

$$\nabla \cdot \vec{A} = \frac{1}{\rho} \frac{\partial(\rho A_\rho)}{\partial \rho} + \frac{1}{\rho} \frac{\partial A_\phi}{\partial \phi} + \frac{\partial A_z}{\partial z} \dots\dots\dots(1.64)$$

and in spherical polar coordinates:

$$\nabla \cdot \vec{A} = \frac{1}{r^2} \frac{\partial(r^2 A_r)}{\partial r} + \frac{1}{r \sin \theta} \frac{\partial(\sin \theta A_\theta)}{\partial \theta} + \frac{1}{r \sin \theta} \frac{\partial A_\phi}{\partial \phi} \dots\dots\dots(1.65)$$

In connection with the divergence of a vector field, the following can be noted

- Divergence of a vector field gives a scalar.

$$\nabla \cdot (\vec{A} + \vec{B}) = \nabla \cdot \vec{A} + \nabla \cdot \vec{B}$$

$$\nabla \cdot (V \vec{A}) = V \nabla \cdot \vec{A} + \vec{A} \cdot \nabla V \dots\dots\dots(1.66)$$

**Divergence theorem :**

Divergence theorem states that the volume integral of the divergence of vector field is equal to the net outward flux of the vector through the closed surface that bounds the

volume. Mathematically,  $\int_V \nabla \cdot \vec{A} dv = \oint_S \vec{A} \cdot d\vec{s}$

Curl of a vector field:

We have defined the circulation of a vector field  $A$  around a closed path as. Curl of a vector field is a measure of the vector field's tendency to rotate about a point. Curl is also defined as a vector whose magnitude is maximum of the net circulation per unit area when the area tends to zero and its direction is the normal direction to the area when the area is oriented in such a way so as to make the circulation maximum. Therefore, we can write:

$$\text{Curl } \vec{A} = \nabla \times \vec{A} = \lim_{\Delta S \rightarrow 0} \frac{\hat{a}_n}{\Delta S} \left[ \oint_C \vec{A} \cdot d\vec{l} \right]_{\text{max}} \dots \dots \dots (1.68)$$

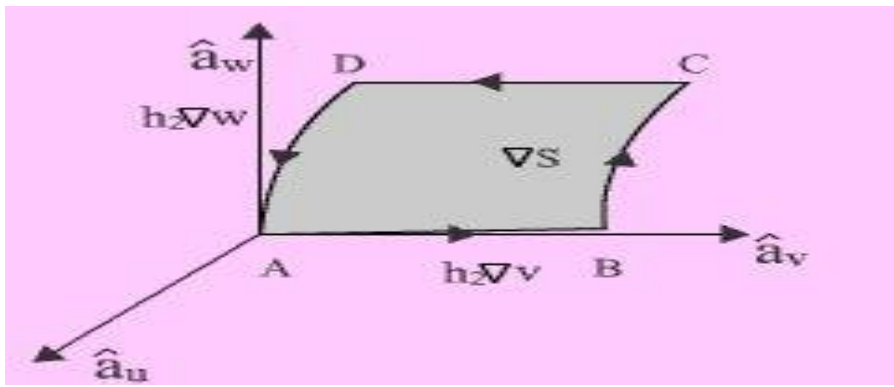

Fig 1.19.a

$C_1$  represents the boundary of  $\Delta S$ , then we can write

$$\oint_{C_1} \vec{A} \cdot d\vec{l} = \int_{AB} \vec{A} \cdot d\vec{l} + \int_{BC} \vec{A} \cdot d\vec{l} + \int_{CD} \vec{A} \cdot d\vec{l} + \int_{DA} \vec{A} \cdot d\vec{l} \quad \dots\dots\dots (1.69)$$

The integrals on the RHS can be evaluated as follows:

$$\int_{AB} \vec{A} \cdot d\vec{l} = (A_u \hat{a}_u + A_v \hat{a}_v + A_w \hat{a}_w) \cdot h_2 \Delta v \hat{a}_v = A_v h_2 \Delta v \quad \dots\dots\dots (1.70)$$

$$\int_{CD} \vec{A} \cdot d\vec{l} = - \left( A_v h_2 \Delta v + \frac{\partial}{\partial w} (A_v h_2 \Delta v) \Delta w \right) \quad \dots\dots\dots (1.71)$$

The negative sign is because of the fact that the direction of traversal reverses. Similarly,

$$\int_{BC} \vec{A} \cdot d\vec{l} = \left( A_w h_3 \Delta w + \frac{\partial}{\partial v} (A_w h_3 \Delta w) \Delta v \right) \quad \dots\dots\dots (1.72)$$

$$\int_{DA} \vec{A} \cdot d\vec{l} = -A_w h_3 \Delta w \quad \dots\dots\dots (1.73)$$

Adding the contribution from all components, we can write:

$$\oint_{C_1} \vec{A} \cdot d\vec{l} = \left( \frac{\partial}{\partial v} (A_w h_3) - \frac{\partial}{\partial w} (A_v h_2) \right) \Delta v \Delta w \quad \dots\dots\dots (1.74)$$

Adding the contribution from all components, we can write:

$$\oint_C \vec{A} \cdot d\vec{l} = \left( \frac{\partial}{\partial v} (A_w h_3) - \frac{\partial}{\partial w} (A_v h_3) \right) \Delta v \Delta w$$

..... (1.74)

Therefore,  $(\nabla \times \vec{A}) \cdot \hat{a}_u = \frac{\oint_C \vec{A} \cdot d\vec{l}}{h_2 h_3 \Delta v \Delta w} = \frac{1}{h_2 h_3} \left( \frac{\partial (h_3 A_w)}{\partial v} - \frac{\partial (h_2 A_v)}{\partial w} \right)$  .....(1.75)

In the same manner if we compute for  $(\nabla \times A) \cdot a_v$  and  $(\nabla \times A) \cdot a_w$  we can write, 30

$$\nabla \times \vec{A} = \frac{1}{h_2 h_3} \left( \frac{\partial (h_3 A_w)}{\partial v} - \frac{\partial (h_2 A_v)}{\partial w} \right) \hat{a}_u + \frac{1}{h_1 h_3} \left( \frac{\partial (h_1 A_u)}{\partial w} - \frac{\partial (h_3 A_w)}{\partial u} \right) \hat{a}_v + \frac{1}{h_1 h_2} \left( \frac{\partial (h_2 A_v)}{\partial u} - \frac{\partial (h_1 A_u)}{\partial v} \right) \hat{a}_w$$

.....(1.76)

This can be written as,

$$\nabla \times \vec{A} = \frac{1}{h_1 h_2 h_3} \begin{vmatrix} h_1 \hat{a}_u & h_2 \hat{a}_v & h_3 \hat{a}_w \\ \frac{\partial}{\partial u} & \frac{\partial}{\partial v} & \frac{\partial}{\partial w} \\ h_1 A_u & h_2 A_v & h_3 A_w \end{vmatrix}$$

.....(1.77)

$$\nabla \times \vec{A} = \begin{vmatrix} \hat{a}_x & \hat{a}_y & \hat{a}_z \\ \frac{\partial}{\partial x} & \frac{\partial}{\partial y} & \frac{\partial}{\partial z} \\ A_x & A_y & A_z \end{vmatrix}$$

In Cartesian coordinates: .....(1.78)

$$\nabla \times \vec{A} = \frac{1}{\rho} \begin{vmatrix} \hat{a}_\rho & \rho \hat{a}_\phi & \hat{a}_z \\ \frac{\partial}{\partial \rho} & \frac{\partial}{\partial \phi} & \frac{\partial}{\partial z} \\ A_\rho & \rho A_\phi & A_z \end{vmatrix} \dots\dots\dots(1.79)$$

In Cylindrical coordinates,

$$\nabla \times \vec{A} = \frac{1}{r^2 \sin \theta} \begin{vmatrix} \hat{a}_r & r \hat{a}_\theta & r \sin \theta \hat{a}_\phi \\ \frac{\partial}{\partial r} & \frac{\partial}{\partial \theta} & \frac{\partial}{\partial \phi} \\ A_r & r A_\theta & r \sin \theta A_\phi \end{vmatrix} \dots\dots\dots(1.80)$$

In Spherical polar coordinates,

Curl operation exhibits the following properties:

- (i) *Curl of a vector field is another vector field.*
- (ii)  $\nabla \times (\vec{A} + \vec{B}) = \nabla \times \vec{A} + \nabla \times \vec{B}$
- (iii)  $\nabla \times (V \vec{A}) = \nabla V \times \vec{A} + V \nabla \times \vec{A}$
- (iv)  $\nabla \cdot (\nabla \times \vec{A}) = 0$
- (v)  $\nabla \times \nabla V = 0$
- (vi)  $\nabla \times (\vec{A} \times \vec{B}) = \vec{A} \nabla \cdot \vec{B} - \vec{B} \nabla \cdot \vec{A} + (\vec{B} \cdot \nabla) \vec{A} - (\vec{A} \cdot \nabla) \vec{B} \dots\dots\dots(1.81)$

Stake's theorem:

It states that the circulation of a vector field around a closed path is equal to the integral of over the surface bounded by this path. It may be noted that this equality holds provided and are continuous on the surface.

$$\oint_L \vec{A} \cdot d\vec{l} = \int_S \nabla \times \vec{A} \cdot d\vec{s} \dots\dots\dots(1.82)$$



Coulomb's Law:

Coulomb's Law states that the force between two point charges  $Q_1$  and  $Q_2$  is directly proportional to the product of the charges and inversely proportional to the square of the distance between them. Point charge is a hypothetical charge located at a single point in space. It is an idealized model of a particle having an electric charge.

Mathematically, where  $k$  is the proportionality constant. In SI units,  $Q_1$  and  $Q_2$  are expressed in Coulombs(C) and  $R$  is in meters.

$$F = \frac{kQ_1Q_2}{R^2} \quad \text{Where} \quad k = \frac{1}{4\pi\epsilon_0}$$

Therefore

$$F = \frac{1}{4\pi\epsilon_0} \frac{Q_1Q_2}{R^2}$$

As shown in the Figure 2.1 let the position vectors of the point charges  $Q_1$  and  $Q_2$  are given by  $\vec{r}_1$  and  $\vec{r}_2$ . Let  $\vec{F}_{12}$  represent the force on  $Q_1$  due to charge  $Q_2$ .

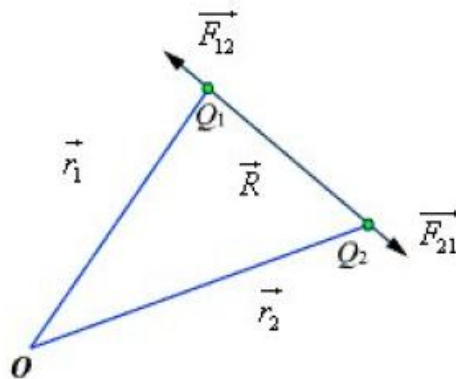

Fig 1.19.b

$$\vec{F} = \frac{Q}{4\pi\epsilon_0} \sum_{i=1}^N \frac{Q_i (\vec{r} - \vec{r}_i)}{|\vec{r} - \vec{r}_i|^3}$$

Electric Field:

The electric field intensity or the electric field strength at a point is defined as the force per unit charge. That is

$$\vec{E} = \lim_{Q \rightarrow 0} \frac{\vec{F}}{Q} \quad \text{or,} \quad \vec{E} = \frac{\vec{F}}{Q}$$

The electric field intensity  $E$  at a point  $r$  (observation point) due a point charge  $Q$  located at  $r'$  (source point) is given by:

$$\vec{E} = \frac{Q(\vec{r} - \vec{r}')}{4\pi\epsilon_0 |\vec{r} - \vec{r}'|^3}$$

Electric flux density:

As stated earlier electric field intensity or simply 'Electric field' gives the strength of the field at a particular point. The electric field depends on the material media in which the field is being considered. The flux density vector is defined to be independent of the material media(as we'll see that it relates to the charge that is producing it).For a linear isotropic medium under

consideration; the flux density vector is  $\vec{D} = \epsilon\vec{E}$  .....(2.11)

We define flux as

$$\psi = \int_S \vec{D} \cdot d\vec{s} \quad \text{.....(2.12)}$$

Gauss's Law:

Gauss's law is one of the fundamental laws of electromagnetism and it states that the total electric flux through a closed surface is equal to the total charge enclosed by the surface.

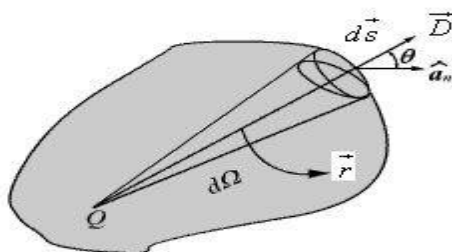

Fig 1.19.c

Let us consider a point charge  $Q$  located in an isotropic homogeneous medium of dielectric constant  $\epsilon$ . The flux density at a distance  $r$  on a surface enclosing the charge is given by

$$\vec{D} = \epsilon \vec{E} = \frac{Q}{4\pi r^2} \hat{a}_r \dots\dots\dots(2.13)$$

If we consider an elementary area  $ds$ , the amount of flux passing through the elementary area is given by

$$d\psi = \vec{D} \cdot ds = \frac{Q}{4\pi r^2} ds \cos \theta \dots\dots\dots(2.14)$$

### Application of Gauss's Law

Gauss's law is particularly useful in computing or where the charge distribution has some symmetry. We shall illustrate the application of Gauss's Law with some examples.

#### 1. An infinite line charge

As the first example of illustration of use of Gauss's law, let consider the problem of determination of the electric field produced by an infinite line charge of density  $\rho_{LC}/m$ . Let us consider a line charge positioned along the  $z$ -axis. Since the line charge is assumed to be infinitely long, the electric field will be of the form as shown. If we consider a close cylindrical surface as shown in Fig. 2.4(a), using Gauss's theorem we can write,

$$\rho_{LC} l = Q = \oint_S \epsilon_0 \vec{E} \cdot d\vec{s} = \int_{S_1} \epsilon_0 \vec{E} \cdot d\vec{s} + \int_{S_2} \epsilon_0 \vec{E} \cdot d\vec{s} + \int_{S_3} \epsilon_0 \vec{E} \cdot d\vec{s} \dots\dots\dots(2.15)$$

Considering the fact that the unit normal vector to areas  $S_1$  and  $S_3$  are perpendicular to the electric field, the surface integrals for the top and bottom surfaces evaluates to zero. Hence we can write,

$$\rho_{LC} l = \epsilon_0 E \cdot 2\pi r l$$

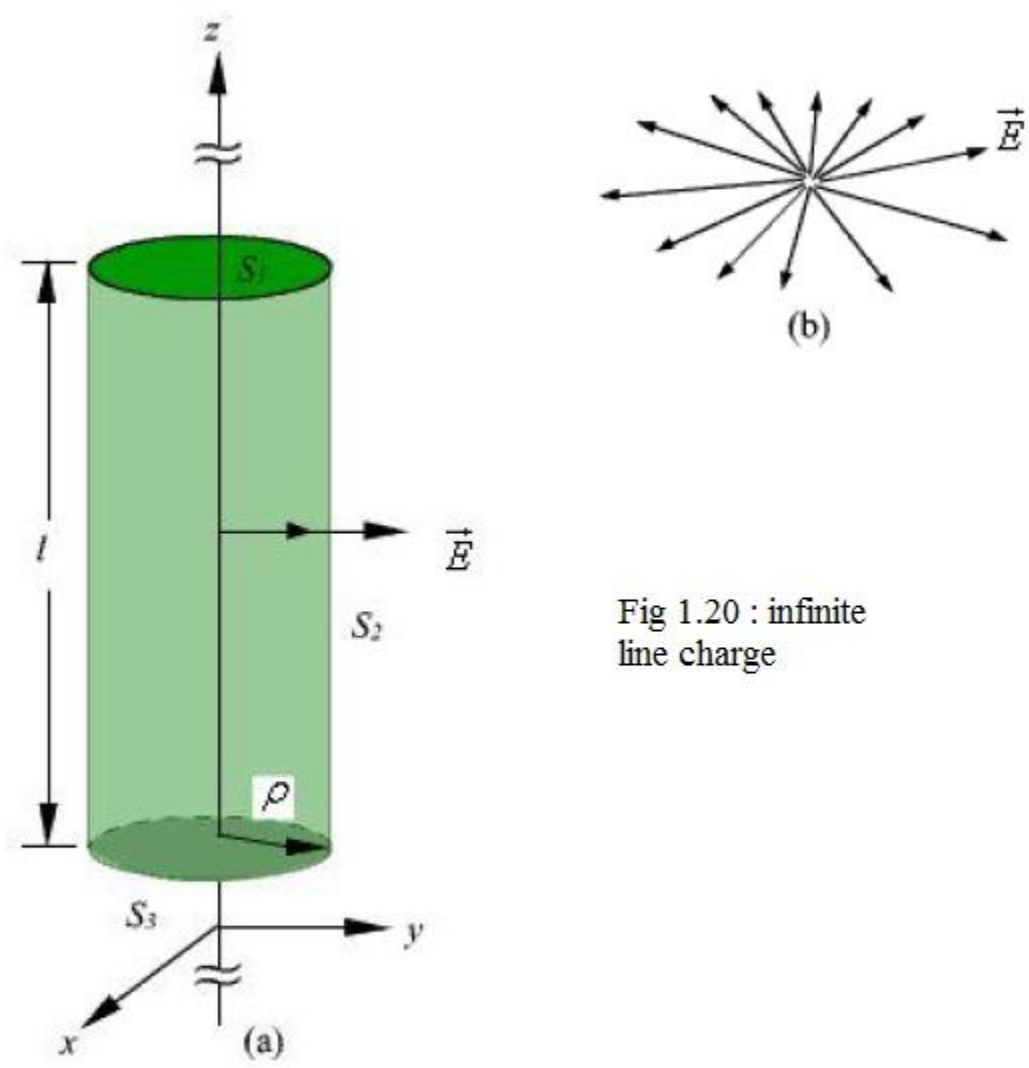

Fig 1.20 : infinite line charge

$$\vec{E} = \frac{\rho_L}{2\pi\epsilon_0\rho} \hat{a}_\rho \dots\dots\dots(2.16)$$

Infinite Sheet of Charge

It may be noted that the electric field strength is independent of distance. This is true for the infinite plane of charge; electric lines of force on either side of the charge will be perpendicular to the sheet and extend to infinity as parallel lines. As number of lines of force per unit area gives the strength of the field, the field becomes independent of distance. For a finite charge sheet, the field will be a function of distance.

### Uniformly Charged Sphere

Let us consider a sphere of radius  $r_0$  having a uniform volume charge density of determine everywhere, inside and outside the sphere, we construct Gaussian surfaces for the infinite surface charge, if we consider a placed symmetrically as shown in figure, we can write:

$$\oint_s \vec{D} \cdot d\vec{s} = 2D\Delta s = \rho_s \Delta s$$

$$\therefore \vec{E} = \frac{\rho_s}{2\epsilon_0} \hat{a}_y \quad \dots\dots\dots(2.17)$$

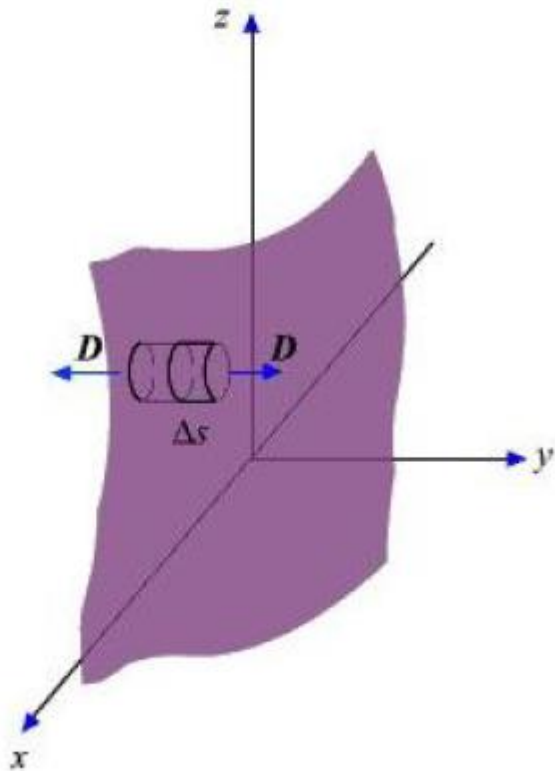

Fig 1.20.a

For the region  $r \leq r_0$ ; the total enclosed charge will be

$$Q_{en} = \rho_v \frac{4}{3} \pi r^3 \dots\dots\dots(2.18)$$

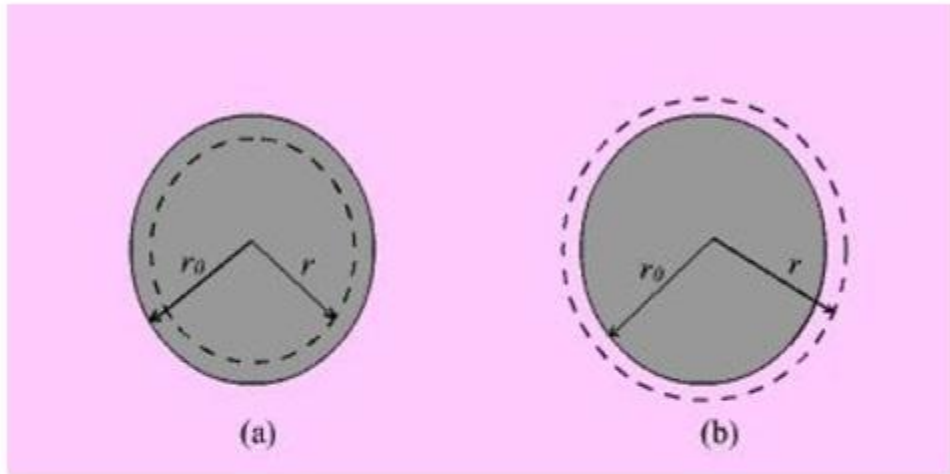

Fig 1.21: UniformlyChargedSphere

By applying Gauss's theorem,

$$\oint_S \vec{D} \cdot d\vec{s} = \int_{\phi=0}^{2\pi} \int_{\theta=0}^{\pi} D_r r^2 \sin \theta d\theta d\phi = 4\pi r^2 D_r = Q_{en} \dots\dots\dots(2.19)$$

$$\vec{E} = \frac{\rho_L}{2\pi\epsilon_0\rho} \hat{a}_r \dots\dots\dots(2.16)$$

Therefore

$$\vec{D} = \frac{r}{3} \rho_v \hat{a}_r \quad 0 \leq r \leq r_0 \quad \dots\dots\dots(2.20)$$

For the region  $r \geq r_0$ ; the total enclosed charge will be

$$Q_{en} = \rho_v \frac{4}{3} \pi r_0^3 \quad \dots\dots\dots(2.21)$$

By applying Gauss's theorem,

$$\vec{D} = \frac{r_0^3}{3r^2} \rho_v \hat{a}_r \quad r \geq r_0 \quad \dots\dots\dots(2.22)$$

Electrostatic Potential and Equipotential Surfaces:

Let us suppose that we wish to move a positive test charge from a point  $P$  to another point  $Q$  as shown in the Fig. below. The force at any point along its path would cause the particle to accelerate and move it out of the region if unconstrained. Since we are dealing with an electrostatic case, a force equal to the negative of that acting on the charge is to be applied while moves from  $P$  to  $Q$ . The work done by this external agent in moving the charge by a distance is given by:

$$dW = -\Delta q \vec{E} d\vec{l} \quad \dots\dots\dots(2.23)$$

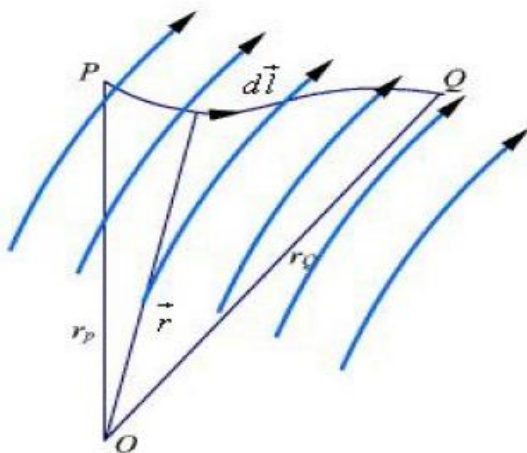

Fig 1.22 Moment of Test Charge

The negative sign accounts for the fact that work is done on the system by the external agent.

$$W = -\Delta q \int_P^Q \vec{E} \cdot d\vec{l} \dots\dots\dots(2.24)$$

The potential difference between two points  $P$  and  $Q$ ,  $V_{PQ}$ , is defined as the work done per unit charge, i.e.

$$V_{PQ} = \frac{W}{\Delta Q} = -\int_P^Q \vec{E} \cdot d\vec{l} \dots\dots\dots(2.25)$$

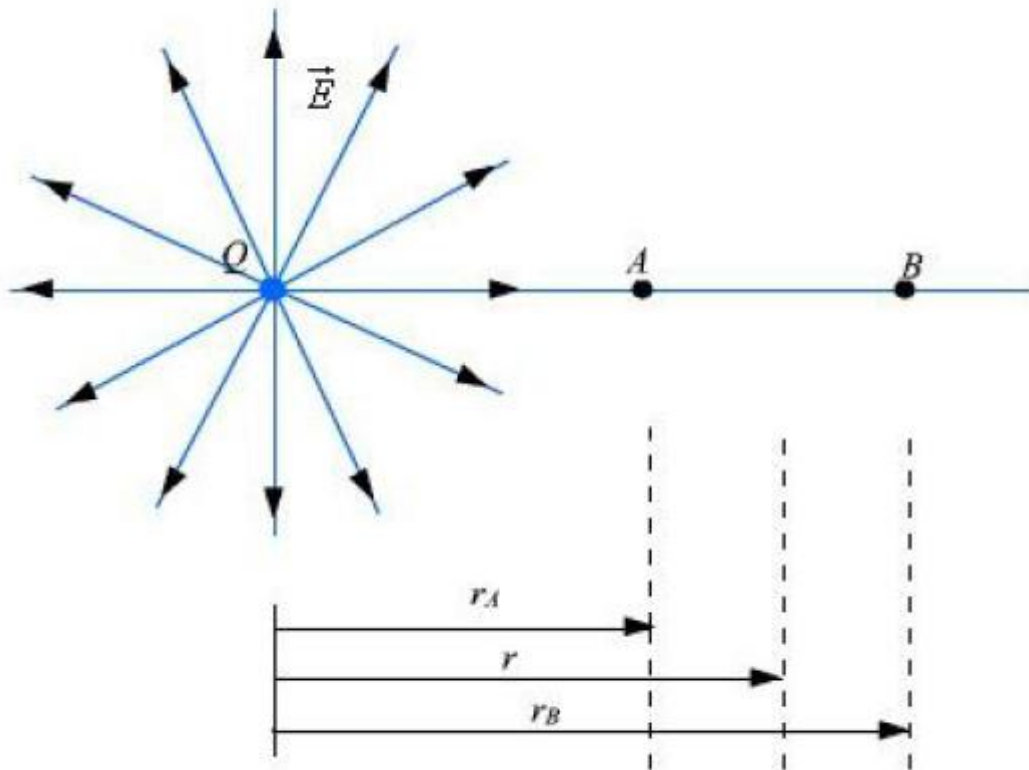

Fig 1.23 Point Charge



Further consider the two points  $A$  and  $B$  as shown in the Fig. 2.9. Considering the movement of a unit positive test charge from  $B$  to  $A$ , we can write an expression for the potential difference as

$$V_{BA} = -\int_B^A \vec{E} \cdot d\vec{l} = -\int_{r_B}^{r_A} \frac{Q}{4\pi\epsilon_0 r^2} \hat{a}_r \cdot dr \hat{a}_r = \frac{Q}{4\pi\epsilon_0} \left[ \frac{1}{r_A} - \frac{1}{r_B} \right] = V_A - V_B \quad \dots\dots\dots(2.26)$$

For line charge, 
$$V(\vec{r}) = \frac{1}{4\pi\epsilon_0} \int_L \frac{\rho_L(\vec{r}') dl'}{|\vec{r} - \vec{r}'|} \quad \dots\dots\dots(2.31)$$

For surface charge, 
$$V(\vec{r}) = \frac{1}{4\pi\epsilon_0} \int_S \frac{\rho_S(\vec{r}') ds'}{|\vec{r} - \vec{r}'|} \quad \dots\dots\dots(2.32)$$

For volume charge, 
$$V(\vec{r}) = \frac{1}{4\pi\epsilon_0} \int_V \frac{\rho_V(\vec{r}') dv'}{|\vec{r} - \vec{r}'|} \quad \dots\dots\dots(2.33)$$

The potential difference is however independent of the choice of reference

$$V_{AB} = V_B - V_A = -\int_A^B \vec{E} \cdot d\vec{l} = \frac{W}{Q} \quad \dots\dots\dots(2.36)$$

We have mentioned that electrostatic field is a conservative field; the work done in moving a charge from one point to the other is independent of the path. Let us consider moving a charge from point  $P1$  to  $P2$  in one path and then from point  $P2$  back to  $P1$  over a different path. If the work done on the two paths were different, a net positive or negative amount of work would have been done when the body returns to its original position  $P1$ . In a conservative field there is no mechanism for dissipating energy corresponding to any positive work neither

any source is present from which energy could be absorbed in the case of negative work. Hence the question of different works in two paths is untenable; the work must have to be independent of path and depends on the initial and final positions. Since the potential difference is independent of the paths taken,  $V_{AB} = -V_{BA}$ , and over a closed path,

$$V_{BA} + V_{AB} = \oint \vec{E} \cdot d\vec{l} = 0 \dots\dots\dots(2.37)$$

$$\oint \vec{E} \cdot d\vec{l} = \int (\nabla \times \vec{E}) \cdot d\vec{s} = 0 \dots\dots\dots(2.38)$$

from which it follows that for electrostatic field,

$$\nabla \times \vec{E} = 0 \dots\dots\dots(2.39)$$

Any vector field  $\vec{A}$  that satisfies  $\nabla \times \vec{A} = 0$  is called an irrotational field.

From our definition of potential, we can write

$$dV = \frac{\partial V}{\partial x} dx + \frac{\partial V}{\partial y} dy + \frac{\partial V}{\partial z} dz = -\vec{E} \cdot d\vec{l}$$

$$\left( \frac{\partial V}{\partial x} \hat{a}_x + \frac{\partial V}{\partial y} \hat{a}_y + \frac{\partial V}{\partial z} \hat{a}_z \right) \cdot (dx \hat{a}_x + dy \hat{a}_y + dz \hat{a}_z) = -\vec{E} \cdot d\vec{l}$$

$$\nabla V \cdot d\vec{l} = -\vec{E} \cdot d\vec{l} \dots\dots\dots(2.40)$$

from which we obtain,

$$\vec{E} = -\nabla V \dots\dots\dots(2.41)$$

### Electric Dipole:

An electric dipole consists of two point charges of equal magnitude but of opposite sign and separated by a small distance. As shown in figure 2.11, the dipole is formed by the two point charges  $Q$  and  $-Q$  separated by a distance  $d$ , the charges being placed symmetrically about the origin. Let us consider a point  $P$  at a distance  $r$ , where we are interested to find the field

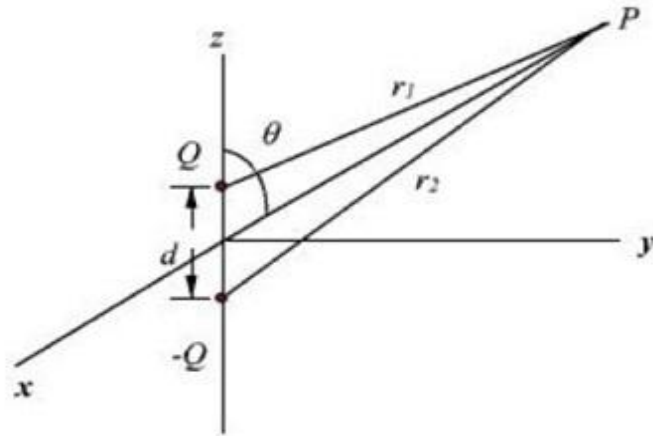

Fig 1.24

The potential at P due to the dipole can be written as:

$$V = \frac{1}{4\pi\epsilon_0} \left[ \frac{Q}{r_1} - \frac{Q}{r_2} \right] = \frac{Q}{4\pi\epsilon_0} \left[ \frac{r_2 - r_1}{r_1 r_2} \right]$$

When  $r_1$  and  $r_2 \gg d$ , we can write  $r_2 - r_1 = 2 \times \frac{d}{2} \cos \theta = d \cos \theta$  and  $r_1 \cong r_2 \cong r$ .

$$\vec{E} = \frac{\rho_L}{2\pi\epsilon_0 Q} \hat{a}_P$$

$\vec{P} = Q\vec{d}$  is the magnitude of the dipole moment. Once again we note that the electric field of electric dipole varies as  $1/r^3$  where as that of a point charge varies as  $1/r^2$ .

Equipotential Surfaces:

An equipotential surface refers to a surface where the potential is constant. The intersection of an equipotential surface with a plane surface results into a path called an equipotential line. No work is done in moving a charge from one point to the other along an equipotential line or surface.

In figure , the dashes lines show the equipotential lines for a positive point charge. By symmetry, the equipotential surfaces are spherical surfaces and the equipotential lines are circles. The solid lines show the flux lines or electric lines of force.

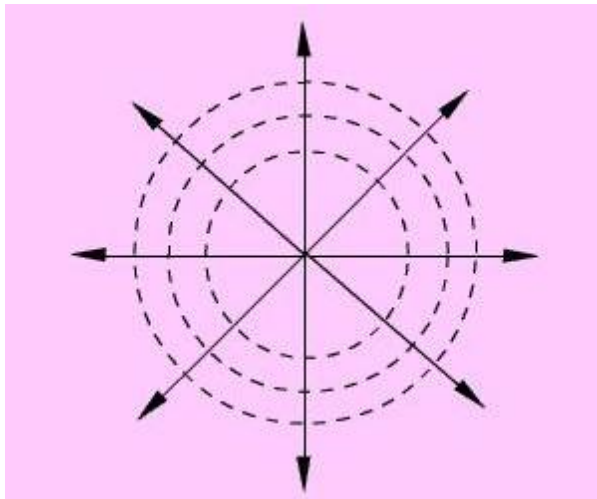

**Fig : Equipotential Lines for a Positive Point Charge**

Michael Faraday as a way of visualizing electric fields introduced flux lines. It may be seen that the electric flux lines and the equipotential lines are normal to each other

*In order to plot the equipotential lines for an electric dipole, we observe that for a given  $Q$  and  $d$ , a constant  $V$  requires that  $\frac{\cos \theta}{r^2}$  is a constant. From this we can write  $r = c_v \sqrt{\cos \theta}$  to be the equation for an equipotential surface and a family of surfaces can be generated for various values of  $c_v$ . When plotted in 2-D this would give equipotential lines*

To determine the equation for the electric field lines, we note that field lines represent the direction of  $\vec{E}$  in space. Therefore

$$d\vec{l} = k\vec{E} \quad , k \text{ is a constant}$$

$$\hat{a}_r dr + r d\theta \hat{a}_\theta + \hat{a}_\phi r \sin \theta = k(\hat{a}_r E_r + \hat{a}_\theta E_\theta + \hat{a}_\phi E_\phi) = d\vec{l}$$

For the dipole under consideration  $E_\phi = 0$  , and therefore we can write,

$$\frac{dr}{E_r} = \frac{rd\theta}{E_\theta}$$

$$\frac{dr}{r} = \frac{2 \cos \theta d\theta}{\sin \theta} = \frac{2d(\sin \theta)}{\sin \theta}$$

Integrating the above expression we get  $r = c_e \sin^2 \theta$  , which gives the equations for electric flux lines. The representative plot (  $cv = c$  assumed) of equipotential lines and flux lines for a dipole is shown in fig . Blue lines represent equipotential, red lines represent field lines.

### Boundary conditions for Electrostatic fields:

In our discussions so far we have considered the existence of electric field in the homogeneous medium. Practical electromagnetic problems often involve media with different physical properties. Determination of electric field for such problems requires the knowledge of the relations of field quantities at an interface between two media. The conditions that the fields must satisfy at the interface of two different media are referred to as **boundary conditions** .

In order to discuss the boundary conditions, we first consider the field behavior in some common material media In general, based on the electric properties, materials can be classified into three categories: conductors, semiconductors and insulators (dielectrics). In *conductor* , electrons in the outermost shells of the atoms are very loosely held and they migrate easily from one atom to the other. Most metals belong to this group. The electrons in the atoms of *insulators* or *dielectrics* remain confined to their orbits and under normal circumstances they are not liberated under the influence of an externally applied field. The electrical properties of

*semiconductors* fall between those of conductors and insulators since semiconductors have very few numbers of free charges.

The parameter *conductivity* is used characterizes the macroscopic electrical property of a material medium. The notion of conductivity is more important in dealing with the current flow and hence the same will be considered in detail later on.

If some free charge is introduced inside a conductor, the charges will experience a force due to mutual repulsion and owing to the fact that they are free to move, the charges will appear on the surface. The charges will redistribute themselves in such a manner that the field within the conductor is zero. Therefore, under steady condition, inside a conductor  $\rho_v = 0$

From Gauss's theorem it follows that

$$\vec{E} = 0 .$$

The surface charge distribution on a conductor depends on the shape of the conductor. The charges on the surface of the conductor will not be in equilibrium if there is a tangential component of the electric field is present, which would produce movement of the charges. Hence under static field conditions, tangential component of the electric field on the conductor surface is zero. The electric field on the surface of the conductor is normal everywhere to the surface . Since the tangential component of electric field is zero, the conductor surface is an equipotential surface. As  $\vec{E} = 0$  inside the conductor, the conductor as a whole has the same potential. We may further note that charges require a finite time to redistribute in a conductor. However, this time is very small sec for good conductor like copper.

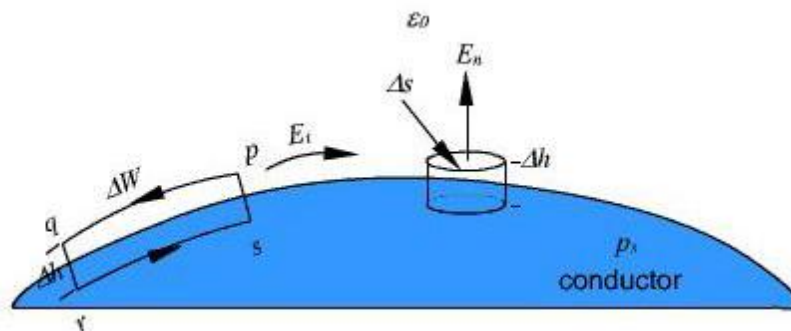

**Fig : Boundary Conditions for at the surface of a Conductor**

Let us now consider an interface between a conductor and free space as shown in the figure

Let us consider the closed path  $pqrsp$  for which we can write,

$$\oint \vec{E} \cdot d\vec{l} = 0$$

For  $\Delta h \rightarrow 0$  and noting that  $\vec{E}$  inside the conductor is zero, we can write

$$E_t \Delta w = 0$$

$E_t$  is the tangential component of the field. Therefore we find that

$$E_t = 0$$

In order to determine the normal component  $E_n$ , the normal component of  $\vec{E}$ , at the surface of the conductor, we consider a small cylindrical Gaussian surface as shown in the Fig. Let  $\Delta s$  represent the area of the top and bottom faces and  $\Delta h$  represents the height of the cylinder. Once again, as  $\Delta h \rightarrow 0$ , we approach the surface of the conductor. Since  $\vec{E} = 0$  inside the conductor is zero,

$$\epsilon_0 \oint \vec{E} \cdot d\vec{s} = \epsilon_0 E_n \Delta s = \rho_s \Delta s$$

$$E_n = \frac{\rho_s}{\epsilon_0}$$

Therefore, we can summarize the boundary conditions at the surface of a conductor as:

$$E_t = 0$$

$$E_n = \frac{\rho_s}{\epsilon_0}$$

### **Behavior of dielectrics in static electric field: Polarization of dielectric:**

Here we briefly describe the behavior of dielectrics or insulators when placed in static electric field. Ideal dielectrics do not contain free charges. As we know, all material media are composed of atoms where a positively charged nucleus (diameter  $\sim 10^{-15}$ m) is surrounded by negatively charged electrons (electron cloud has radius  $\sim 10^{-10}$ m) moving around the nucleus. Molecules of dielectrics are neutral macroscopically; an externally applied field causes small displacement of

the charge particles creating small electric dipoles. These induced dipole moments modify electric fields both inside and outside dielectric material.

Molecules of some dielectric materials possess permanent dipole moments even in the absence of an external applied field. Usually such molecules consist of two or more dissimilar atoms and are called *polar* molecules. A common example of such molecule is water molecule  $H_2O$ . In polar molecules the atoms do not arrange themselves to make the net dipole moment zero. However, in the absence of an external field, the molecules arrange themselves in a random manner so that net dipole moment over a volume becomes zero. Under the influence of an applied electric field, these dipoles tend to align themselves along the field as shown in figure . There are some materials that can exhibit net permanent dipole moment even in the absence of applied field. These materials are called *electrets* that made by heating certain waxes or plastics in the presence of electric field. The applied field aligns the polarized molecules when the material is in the heated state and they are frozen to their new position when after the temperature is brought down to its normal temperatures. Permanent polarization remains without an externally applied field.

As a measure of intensity of polarization, polarization vector  $\vec{P}$  (in C/m<sup>2</sup>) is defined as:

$$\vec{P} = \lim_{\Delta v \rightarrow 0} \frac{\sum_{i=1}^{n\Delta v} \vec{P}_k}{\Delta v}$$

$n$  being the number of molecules per unit volume i.e.  $\vec{P}$  is the dipole moment per unit volume.

Let us now consider a dielectric material having polarization  $\vec{P}$  and compute the potential at an external point O due to an elementary dipole  $\vec{P} dv'$ .



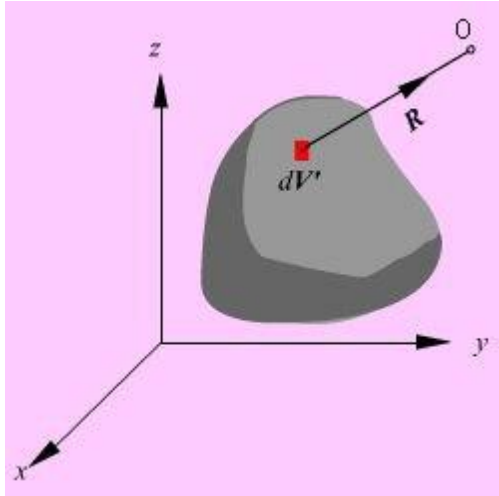

**Fig : Potential at an External Point due to an Elementary Dipole  $dV'$ .**

With reference to the figure, we can write:

$$dV = \frac{\vec{P} \cdot \hat{a}_R}{4\pi\epsilon_0 R^2} dv'$$

Therefore,

$$V = \int_V \frac{\vec{P} \cdot \hat{a}_R}{4\pi\epsilon_0 R^2} dv'$$

$$R = \left\{ (x - x')^2 + (y - y')^2 + (z - z')^2 \right\}^{1/2}$$

Where  $x, y, z$  represent the coordinates of the external point  $O$  and  $x', y', z'$  are the coordinates of the source point.

From the expression of  $R$ , we can verify that

$$\nabla' \left( \frac{1}{R} \right) = \frac{\hat{a}_R}{R^2}$$

$$V = \frac{1}{4\pi\epsilon_0} \int_V \vec{P} \cdot \nabla' \left( \frac{1}{R} \right) dv'$$

Using the vector identity,  $\nabla' \cdot (f\vec{A}) = f\nabla' \cdot \vec{A} + \vec{A} \cdot \nabla' f$ , where  $f$  is a scalar quantity, we have,

$$V = \frac{1}{4\pi\epsilon_0} \left[ \int_V \nabla' \cdot \left( \frac{\vec{P}}{R} \right) dv' - \int_V \frac{\nabla' \cdot \vec{P}}{R} dv' \right]$$

Converting the first volume integral of the above expression to surface integral, we can write

$$V = \frac{1}{4\pi\epsilon_0} \oint_S \frac{\vec{P} \cdot \hat{a}_n}{R} ds' + \frac{1}{4\pi\epsilon_0} \int_V \frac{(-\nabla \cdot \vec{P})}{R} dv'$$

Where  $\hat{a}_n$  is the outward normal from the surface element  $ds'$  of the dielectric. From the above expression we find that the electric potential of a polarized dielectric may be found from the contribution of volume and surface charge distributions having densities

$$\rho_{ps} = \vec{P} \cdot \hat{a}_n$$

$$\rho_{pv} = -\nabla \cdot \vec{P}$$

These are referred to as polarisation or bound charge densities. Therefore we may replace a polarized dielectric by an equivalent polarization surface charge density and a polarization volume charge density. We recall that bound charges are those charges that are not free to move within the dielectric material, such charges are result of displacement that occurs on a molecular scale during polarization. The total bound charge on the surface is

$$\oint_S \rho_{ps} ds = \oint_S \vec{P} \cdot d\vec{s}$$

The charge that remains inside the surface is

$$\int_V \rho_{pv} dv = \int_V -\nabla \cdot \vec{P} dv$$

The total charge in the dielectric material is zero as

$$\oint_S \rho_{ps} ds + \int_V \rho_{pv} = \oint_S \vec{P} \cdot d\vec{s} + \int_V -\nabla \cdot \vec{P} dv = \int_V \nabla \cdot \vec{P} - \int_V \nabla \cdot \vec{P} = 0$$

If we now consider that the dielectric region containing charge density  $\rho_v$  the total volume charge density becomes

$$\rho_t = \rho_v + \rho_{pv}$$

Since we have taken into account the effect of the bound charge density, we can write

$$\nabla \cdot \vec{E} = \frac{(\rho_v + \rho_{pv})}{\epsilon_0}$$

Using the definition of  $\rho_v$  we have

$$\nabla \cdot (\epsilon_0 \vec{E} + \vec{P}) = \rho_v$$

Therefore the electric flux density

$$\vec{D} = \epsilon_0 \vec{E} + \vec{P}$$

When the dielectric properties of the medium are linear and isotropic, polarisation is directly proportional to the applied field strength and

$$\vec{P} = \epsilon_0 \chi_e \vec{E}$$

is the electric susceptibility of the dielectric. Therefore,

$$\vec{D} = \epsilon_0 (1 + \chi_e) \vec{E} = \epsilon_0 \epsilon_r \vec{E} = \epsilon \vec{E}$$

$\epsilon_r = 1 + \chi_e$  is called relative permeability or the dielectric constant of the medium.  $\epsilon_0 \epsilon_r$  is called the absolute permittivity.

A dielectric medium is said to be linear when  $\chi_e$  is independent of  $\vec{E}$  and the medium is homogeneous if  $\chi_e$  is also independent of space coordinates. A linear homogeneous and isotropic medium is called a **simple medium** and for such medium the relative permittivity is a constant.

Dielectric constant  $\epsilon_r$  may be a function of space coordinates. For anisotropic materials, the dielectric constant is different in different directions of the electric field, D and E are related by a permittivity tensor which may be written as:

$$\begin{bmatrix} D_x \\ D_y \\ D_z \end{bmatrix} = \begin{bmatrix} \epsilon_{11} & \epsilon_{12} & \epsilon_{13} \\ \epsilon_{21} & \epsilon_{22} & \epsilon_{23} \\ \epsilon_{31} & \epsilon_{32} & \epsilon_{33} \end{bmatrix} \begin{bmatrix} E_x \\ E_y \\ E_z \end{bmatrix}$$

For crystals, the reference coordinates can be chosen along the principal axes, which make off diagonal elements of the permittivity matrix zero. Therefore, we have

$$\begin{bmatrix} D_x \\ D_y \\ D_z \end{bmatrix} = \begin{bmatrix} \epsilon_1 & 0 & 0 \\ 0 & \epsilon_2 & 0 \\ 0 & 0 & \epsilon_3 \end{bmatrix} \begin{bmatrix} E_x \\ E_y \\ E_z \end{bmatrix}$$

Media exhibiting such characteristics are called **biaxial**. Further, if  $\epsilon_1 = \epsilon_2$  then the medium is called **uniaxial**. It may be noted that for isotropic media,  $\epsilon_1 = \epsilon_2 = \epsilon_3$ .

Lossy dielectric materials are represented by a complex dielectric constant, the imaginary part of which provides the power loss in the medium and this is in general dependant on frequency.

Another phenomenon of importance is **dielectric breakdown**. We observed that the applied electric field causes small displacement of bound charges in a dielectric material that results into polarization. Strong field can pull electrons completely out of the molecules. These electrons being accelerated under influence of electric field will collide with molecular lattice structure causing damage or distortion of material. For very strong fields, avalanche breakdown may also occur. The dielectric under such condition will become conducting.

The maximum electric field intensity a dielectric can withstand without breakdown is referred to as the **dielectric strength** of the material.

### Boundary Conditions for Electrostatic Fields:

Let us consider the relationship among the field components that exist at the interface between two dielectrics as shown in the figure. The permittivity of the medium 1 and medium 2 are  $\epsilon_1$  and  $\epsilon_2$  respectively and the interface may also have a net charge density

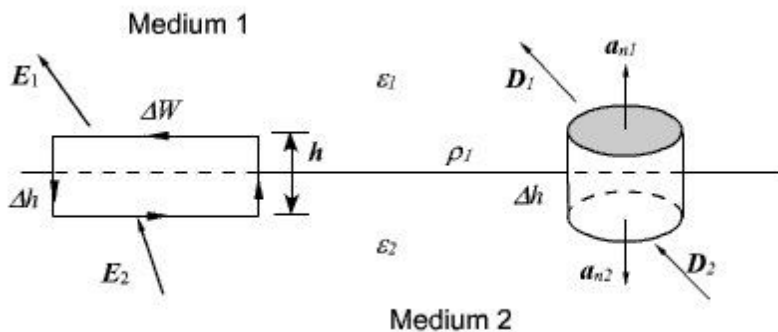

**Fig : Boundary Conditions at the interface between two dielectrics**

We can express the electric field in terms of the tangential and normal components

$$\vec{E}_1 = \vec{E}_{1t} + \vec{E}_{1n}$$

$$\vec{E}_2 = \vec{E}_{2t} + \vec{E}_{2n}$$

Where  $E_t$  and  $E_n$  are the tangential and normal components of the electric field respectively.

Let us assume that the closed path is very small so that over the elemental path length the variation of  $E$  can be neglected. Moreover very near to the interface,  $\Delta h \rightarrow 0$

Therefore

$$\oint \vec{E} \cdot d\vec{l} = E_{1t} \Delta w - E_{2t} \Delta w + \frac{h}{2} (E_{1n} + E_{2n}) - \frac{h}{2} (E_{1n} + E_{2n}) = 0$$

Thus, we have,  $E_{1t} = E_{2t}$  or  $\frac{D_{1t}}{\epsilon_1} = \frac{D_{2t}}{\epsilon_2}$  i.e. the tangential component of an electric field is continuous across the interface.

For relating the flux density vectors on two sides of the interface we apply Gauss's law to a small pillbox volume as shown in the figure. Once again as,  $\Delta h \rightarrow 0$  we can write

$$\oint \vec{D} \cdot d\vec{s} = (\vec{D}_1 \cdot \hat{a}_{n2} + \vec{D}_2 \cdot \hat{a}_{n1}) \Delta s = \rho_s \Delta s$$

$$\text{i.e., } D_{1n} - D_{2n} = \rho_s$$

$$\epsilon_1 E_{1n} - \epsilon_2 E_{2n} = \rho_s$$

Thus we find that the normal component of the flux density vector  $D$  is discontinuous across an interface by an amount of discontinuity equal to the surface charge density at the interface.

### Example

Two further illustrate these points; let us consider an example, which involves the refraction of  $D$  or  $E$  at a charge free dielectric interface as shown in the figure

Using the relationships we have just derived, we can write

$$E_{1t} = E_1 \sin \theta_1 = \frac{D_1}{\epsilon_1} \sin \theta_1 = E_{2t} = E_2 \sin \theta_2 = \frac{D_2}{\epsilon_2} \sin \theta_2$$

$$D_{1n} = D_1 \cos \theta_1 = D_{2n} = D_2 \cos \theta_2$$

In terms of flux density vectors,

$$\frac{D_1}{\epsilon_1} \sin \theta_1 = \frac{D_2}{\epsilon_2} \sin \theta_2$$

$$D_1 \cos \theta_1 = D_2 \cos \theta_2$$

$$\text{Therefore, } \frac{\tan \theta_1}{\tan \theta_2} = \frac{\epsilon_1}{\epsilon_2} = \frac{\epsilon_{r1}}{\epsilon_{r2}}$$

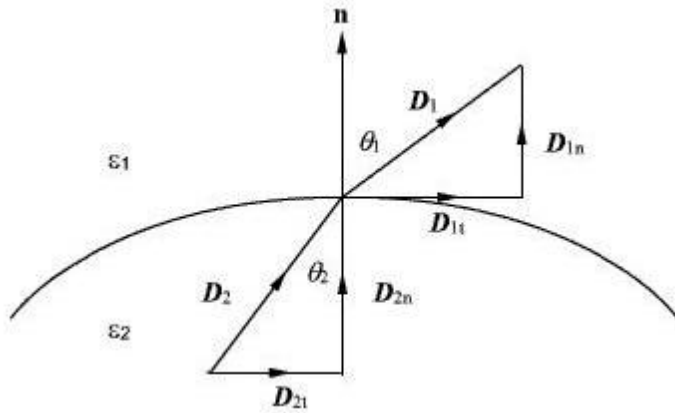

**Fig : Refraction of D or E at a Charge Free Dielectric Interface**

### Capacitance and Capacitors:

We have already stated that a conductor in an electrostatic field is an Equipotential body and any charge given to such conductor will distribute themselves in such a manner that electric field inside the conductor vanishes. If an additional amount of charge is supplied to an isolated conductor at a given potential, this additional charge will increase the surface charge density.

Since the potential of the conductor is given by  $V = \frac{1}{4\pi\epsilon_0} \int \frac{\rho_s ds'}{r}$ , the potential of the conductor

will also increase maintaining the ratio  $\frac{Q}{V}$  same. Thus we can write  $C = \frac{Q}{V}$  where the constant of proportionality  $C$  is called the capacitance of the isolated conductor. SI unit of capacitance is Coulomb/ Volt also called Farad denoted by  $F$ . It can be seen that if  $V=1$ ,  $C = Q$ . Thus capacity of an isolated conductor can also be defined as the amount of charge in Coulomb required to raise the potential of the conductor by 1 Volt.

Of considerable interest in practice is a capacitor that consists of two (or more) conductors carrying equal and opposite charges and separated by some dielectric media or free space. The conductors may have arbitrary shapes. A two-conductor capacitor is shown in figure

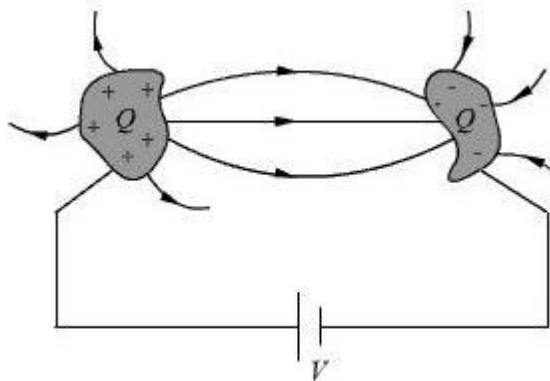

Fig : Capacitance and Capacitors

When a d-c voltage source is connected between the conductors, a charge transfer occurs which results into a positive charge on one conductor and negative charge on the other conductor. The conductors are equipotential surfaces and the field lines are perpendicular to the conductor surface. If  $V$  is the mean potential difference between the conductors, the capacitance is given by  $C = \frac{Q}{V}$ . Capacitance of a capacitor depends on the geometry of the conductor and the permittivity of the medium between them and does not depend on the charge or potential difference between conductors. The capacitance can be computed by assuming  $Q$  (at the same time  $-Q$  on the other

conductor), first determining  $\vec{E}$  using Gauss's theorem and then determining  $V = -\int \vec{E} \cdot d\vec{l}$ . We illustrate this procedure by taking the example of a parallel plate capacitor.

**Example: Parallel plate capacitor**

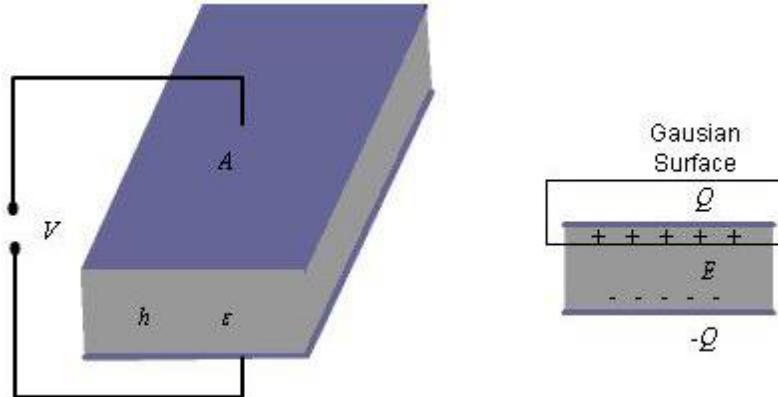

Fig : Parallel Plate Capacitor

For the parallel plate capacitor shown in the figure 2.20, let each plate has area  $A$  and a distance  $h$  separates the plates. A dielectric of permittivity fills the region between the plates. The electric field lines are confined between the plates. We ignore the flux fringing at the edges of the plates and charges are assumed to be uniformly distributed over the

conducting plates with densities  $\rho_s$  and  $-\rho_s$ ,  $\rho_s = \frac{Q}{A}$

By Gauss's theorem we can write, 
$$E = \frac{\rho_s}{\epsilon} = \frac{Q}{A\epsilon}$$

As we have assumed  $\rho_s$  to be uniform and fringing of field is neglected, we see that E is constant in the region between the plates and therefore, we can write  $V = Eh = \frac{hQ}{\epsilon A}$ . Thus,

for a parallel plate capacitor we have, 
$$C = \frac{Q}{V} = \epsilon \frac{A}{h}$$

### Series and parallel Connection of capacitors :

Capacitors are connected in various manners in electrical circuits; series and parallel connections are the two basic ways of connecting capacitors. We compute the equivalent capacitance for such connections.

**Series Case:** Series connection of two capacitors is shown in the figure. For this case we can write,

$$V = V_1 + V_2 = \frac{Q}{C_1} + \frac{Q}{C_2}$$

$$\frac{V}{Q} = \frac{1}{C_{eqs}} = \frac{1}{C_1} + \frac{1}{C_2}$$

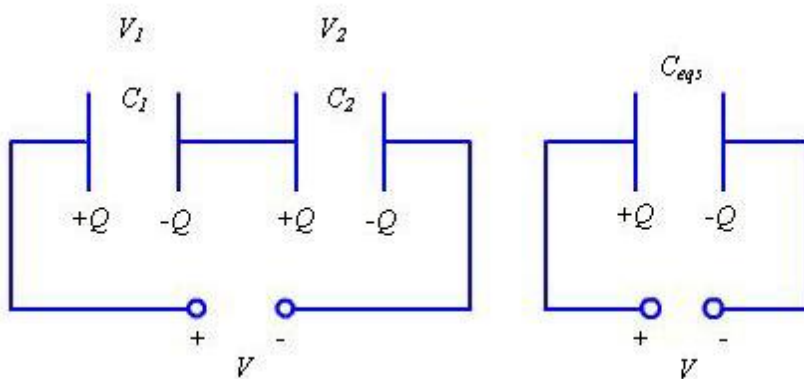

**Fig : Series Connection of Capacitors**



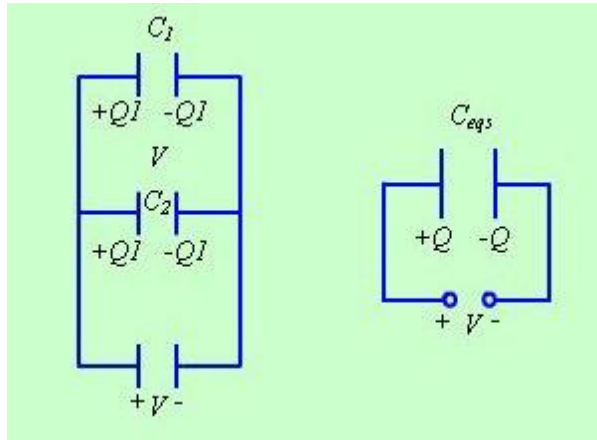

**Fig : Parallel Connection of Capacitors**

The same approach may be extended to more than two capacitors connected in series.

**Parallel Case:** For the parallel case, the voltages across the capacitors are the same.

The total charge  $Q = Q_1 + Q_2 = C_1V + C_2V$

Therefore,

$$C_{eqs} = \frac{Q}{V} = C_1 + C_2$$

**Electrostatic Energy and Energy Density :**

We have stated that the electric potential at a point in an electric field is the amount of work required to bring a unit positive charge from infinity (reference of zero potential) to that point. To determine the energy that is present in an assembly of charges, let us first determine the amount of work required to assemble them. Let us consider a number of discrete charges  $Q_1, Q_2, \dots, Q_N$  are brought from infinity to their present position one by one. Since initially there is no field present, the amount of work done in bring  $Q_1$  is zero.  $Q_2$  is brought in the presence of the field of  $Q_1$ , the work done  $W_1 = Q_2V_{21}$  where  $V_{21}$  is the potential at the location of  $Q_2$  due to  $Q_1$ . Proceeding in this manner, we can write, the total work done

$$W = V_{21}Q_2 + (V_{31}Q_3 + V_{32}Q_3) + \dots + (V_{N1}Q_N + \dots + V_{N(N-1)}Q_N)$$

Had the charges been brought in the reverse order,

$$W = (V_{1N}Q_1 + \dots + V_{12}Q_1) + \dots + (V_{(N-2)(N-1)}Q_{N-2} + V_{(N-2)N}Q_{N-2}) + V_{(N-1)N}Q_{N-1}$$

Therefore,

$$2W = (V_{1N} + V_{1(N-1)} + \dots + V_{12})Q_1 + (V_{2N} + V_{2(N-1)} + \dots + V_{23} + V_{21})Q_2 \dots$$

$$\dots + (V_{N1} + \dots + V_{N2} + V_{N(N-1)})Q_N$$

Here  $V_{IJ}$  represent voltage at the  $I$ th charge location due to  $J$ th charge. Therefore,

$$2W = V_1Q_1 + \dots + V_NQ_N = \sum_{I=1}^N V_I Q_I$$

Or,

$$W = \frac{1}{2} \sum_{I=1}^N V_I Q_I$$

If instead of discrete charges, we now have a distribution of charges over a volume  $v$  then we can write,

$$W = \frac{1}{2} \int_V V \rho_v dv$$

Where  $\rho_v$  is the volume charge density and  $V$  represents the potential function.

Since,  $\rho_v = \nabla \cdot \vec{D}$ , we can write

$$W = \frac{1}{2} \int_V (\nabla \cdot \vec{D}) V dv$$

Using the vector identity,

$$\nabla \cdot (V \vec{D}) = \vec{D} \cdot \nabla V + V \nabla \cdot \vec{D}, \text{ we can write}$$

$$W = \frac{1}{2} \int_V (\nabla \cdot (V \vec{D}) - \vec{D} \cdot \nabla V) dv$$

$$= \frac{1}{2} \oint_V (V \vec{D}) \cdot d\vec{s} - \frac{1}{2} \int_V (\vec{D} \cdot \nabla V) dv$$

In the expression  $\frac{1}{2} \oint_V (V \vec{D}) \cdot d\vec{s}$ , for point charges, since  $V$  varies as  $\frac{1}{r}$  and  $D$  varies as  $\frac{1}{r^2}$ , the term  $V \vec{D}$  varies as  $\frac{1}{r^3}$  while the area varies as  $r^2$ . Hence the integral term varies at least as  $\frac{1}{r}$  and as surface becomes large (i.e.  $r \rightarrow \infty$ ) the integral term tends to zero. Thus the equation for  $W$  reduces to

$$W = -\frac{1}{2} \int_V (\vec{D} \cdot \nabla V) dv = \frac{1}{2} \int_V (\vec{D} \cdot \vec{E}) dv = \frac{1}{2} \int_V (\epsilon E^2) dv = \int_V w_e dv$$

$w_e = \frac{1}{2} \epsilon E^2$ , is called the energy density in the electrostatic field.

Poisson's and Laplace's Equations:

For electrostatic field, we have seen that

$$\begin{aligned}\nabla \cdot \vec{D} &= \rho_v \\ \vec{E} &= -\nabla V\end{aligned}$$

Form the above two equations we can write

$$\nabla \cdot (\epsilon \vec{E}) = \nabla \cdot (-\epsilon \nabla V) = \rho_v$$

Using vector identity we can write,  $\epsilon \nabla \cdot \nabla V + \nabla V \cdot \nabla \epsilon = -\rho_v$

For a simple homogeneous medium,  $\epsilon$  is constant and  $\nabla \epsilon = 0$ . Therefore,

$$\nabla \cdot \nabla V = \nabla^2 V = -\frac{\rho_v}{\epsilon}$$

This equation is known as **Poisson's equation**. Here we have introduced a new operator, (del square), called the Laplacian operator. In Cartesian coordinates,

$$\nabla^2 V = \nabla \cdot \nabla V = \left( \frac{\partial}{\partial x} \hat{a}_x + \frac{\partial}{\partial y} \hat{a}_y + \frac{\partial}{\partial z} \hat{a}_z \right) \cdot \left( \frac{\partial V}{\partial x} \hat{a}_x + \frac{\partial V}{\partial y} \hat{a}_y + \frac{\partial V}{\partial z} \hat{a}_z \right)$$

Therefore, in Cartesian coordinates, Poisson equation can be written as:

$$\frac{\partial^2 V}{\partial x^2} + \frac{\partial^2 V}{\partial y^2} + \frac{\partial^2 V}{\partial z^2} = -\frac{\rho_v}{\epsilon}$$

In cylindrical coordinates,

$$\nabla^2 V = \frac{1}{r} \frac{\partial}{\partial r} \left( r \frac{\partial V}{\partial r} \right) + \frac{1}{r^2} \frac{\partial^2 V}{\partial \phi^2} + \frac{\partial^2 V}{\partial z^2}$$

In spherical polar coordinate system,

$$\nabla^2 V = \frac{1}{r^2} \frac{\partial}{\partial r} \left( r^2 \frac{\partial V}{\partial r} \right) + \frac{1}{r^2 \sin \theta} \frac{\partial}{\partial \theta} \left( \sin \theta \frac{\partial V}{\partial \theta} \right) + \frac{1}{r^2 \sin^2 \theta} \frac{\partial^2 V}{\partial \phi^2}$$

At points in simple media, where no free charge is present, Poisson's equation reduces to

$$\nabla^2 V = 0,$$

which is known as Laplace's equation.

Laplace's and Poisson's equation are very useful for solving many practical electrostatic field problems where only the electrostatic conditions (potential and charge) at some boundaries are known and solution of electric field and potential is to be found throughout the volume. We shall consider such applications in the section where we deal with boundary value problems.

### Method of Images:

The uniqueness theorem for Poisson's or Laplace's equations, which we studied in the last couple of lectures, has some interesting consequences. Frequently, it is not easy to obtain an analytic solution to either of these equations. Even when it is possible to do so, it may require rigorous mathematical tools. Occasionally, however, one can guess a solution to a problem, by some intuitive method. When this becomes feasible, the uniqueness theorem tells us that the solution must be the one we are looking for. One such intuitive method is the "method of images" a terminology borrowed from optics. In this lecture, we illustrate this method by some examples.

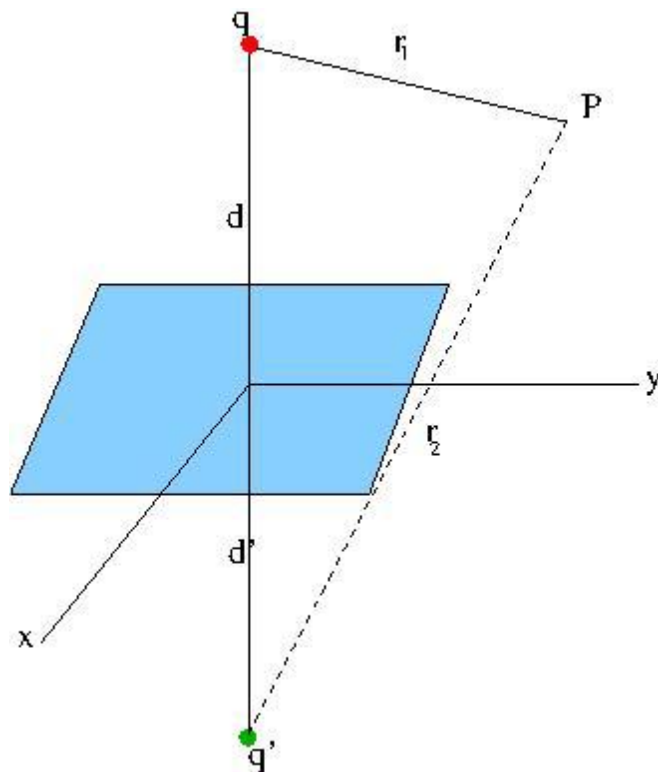

Consider an infinite, grounded conducting plane occupying which occupies the  $x$ - $y$  plane. A charge  $q$  is located at a distance  $d$  from this plane, the location of the charge is taken along the  $z$  axis. We are required to obtain an expression for the potential everywhere in the region  $z > 0$ , excepting of course, at the location of the charge itself. Let us look at the potential at the point  $P$  which is at a distance  $r_1$  from the charge  $q$  (indicated by a red circle in the figure).

## MODULE-II

A definite link between electric and magnetic fields was established by Oersted in 1820. As we have noticed, an electrostatic field is produced by static or stationary charges. If the charges are moving with constant velocity, a static magnetic (or magneto static) field is produced. A magneto static field is produced by a constant current flow (or direct current). This current flow may be due to magnetization currents as in permanent magnets, electron-beam currents as in vacuum tubes, or conduction currents as in current-carrying wires. In this chapter, we consider magnetic fields in free space due to direct current.

Analogy between Electric and Magnetic Fields.

Term	Electric	Magnetic
Basic laws	$\mathbf{F} = \frac{Q_1 Q_2}{4\pi\epsilon_r^2} \mathbf{a}_r$	$d\mathbf{B} = \frac{\mu_0 I d\mathbf{l} \times \mathbf{a}}{4\pi R^2}$
	$\oint \mathbf{D} \cdot d\mathbf{S} = Q_{\text{enc}}$	$\oint \mathbf{H} \cdot d\mathbf{l} = I_{\text{enc}}$
Force law	$\mathbf{F} = QE$	$\mathbf{F} = Q\mathbf{u} \times \mathbf{B}$
Source element	$dQ$	$Q\mathbf{u} = I d\mathbf{l}$
Field intensity	$E = \frac{V}{\ell} \text{ (V/m)}$	$H = \frac{I}{\ell} \text{ (A/m)}$
Flux density	$\mathbf{D} = \frac{\Psi}{S} \text{ (C/m}^2\text{)}$	$\mathbf{B} = \frac{\Psi}{S} \text{ (Wb/m}^2\text{)}$
Relationship between fields	$\mathbf{D} = \epsilon\mathbf{E}$	$\mathbf{B} = \mu\mathbf{H}$
Potentials	$\mathbf{E} = -\nabla V$	$\mathbf{H} = -\nabla V_m \text{ (J =)}$
	$V = \int \frac{\rho_L dl}{4\pi\epsilon r}$	$\mathbf{A} = \int \frac{\mu I d\mathbf{l}}{4\pi R}$
Flux	$\Psi = \int \mathbf{D} \cdot d\mathbf{S}$	$\Psi = \int \mathbf{B} \cdot d\mathbf{S}$
	$\Psi = Q = CV$	$\Psi = LI$
	$I = C \frac{dV}{dt}$	$V = L \frac{dI}{dt}$
Energy density	$w_E = \frac{1}{2} \mathbf{D} \cdot \mathbf{E}$	$w_m = \frac{1}{2} \mathbf{B} \cdot \mathbf{H}$
Poisson's equation	$\nabla^2 V = -\frac{\rho_v}{\epsilon}$	$\nabla^2 \mathbf{A} = -\mu\mathbf{J}$

**Biot-Savart's** law states that the magnetic field intensity  $dH$  produced at a point P, as shown in Figure below, by the differential current element  $I dl$  is proportional to the product  $dl$  and the sine of the angle  $\alpha$  between the element and the line joining P to the element and is inversely proportional to the square of the distance R between P and the element.

That is

Fig 2.2.1

$$dH \propto \frac{I dl \sin \alpha}{R^2}$$

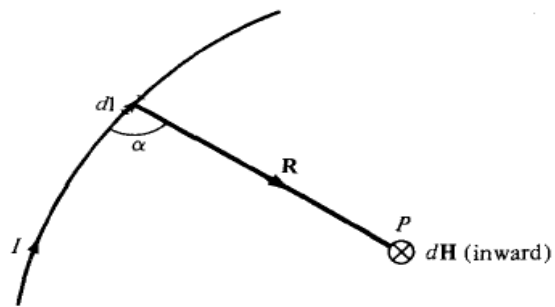

$$dH = \frac{kI dl \sin \alpha}{R^2}$$

Where  $k$  is the constant of proportionality. In SI units,  $k = 1/4\pi$ , so the above equation becomes

$$dH = \frac{I dl \sin \alpha}{4\pi R^2}$$

From the definition of cross product in above equation it is easy to notice that the above equation is better put in vector form as

$$d\mathbf{H} = \frac{I d\mathbf{l} \times \mathbf{a}_R}{4\pi R^2} = \frac{I d\mathbf{l} \times \mathbf{R}}{4\pi R^3}$$

Where  $R = |\mathbf{R}|$  and  $\mathbf{a}_R = \mathbf{R}/R$ . Thus the direction of  $d\mathbf{H}$  can be determined by the right-hand rule with the right-hand thumb pointing in the direction of the current, the right-hand fingers encircling the wire in the direction of  $d\mathbf{H}$  as shown in Figure 2.21. Alternatively, we can use the right-handed screw rule to determine the direction of  $d\mathbf{H}$ : with the screw placed along the wire and pointed in the direction of current flow, the direction of advance of the screw is the direction of  $d\mathbf{H}$  as in Figure 2.2.1

Determining the direction of  $d\mathbf{H}$  using (a) the right-hand rule, or (b) the right-handed screw rule.

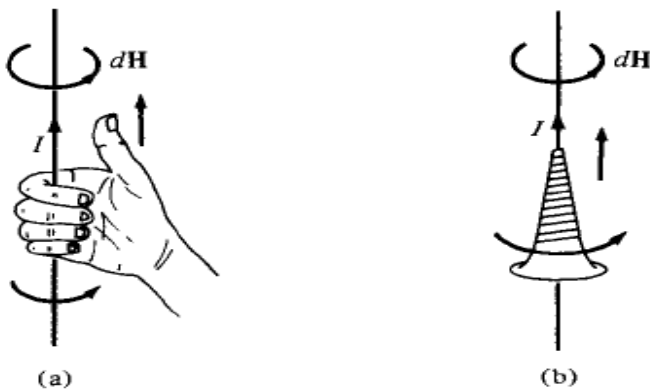

It is customary to represent the direction of the magnetic field intensity  $\mathbf{H}$  by a small circle with a dot or cross sign depending on whether  $\mathbf{H}$  (or  $I$ ) is out of, or into, the page. Just as we can have different charge configurations, we can have different current distributions: line current, surface current, and volume current. If we define  $\mathbf{K}$  as the surface current density (in amperes/meter) and  $\mathbf{J}$  as the volume current density (in amperes/meter square), the source elements are related as

$$I d\mathbf{l} \equiv \mathbf{K} dS \equiv \mathbf{J} dv$$

Thus in terms of the distributed current sources, the **Biot-Savart** law becomes



$$\mathbf{H} = \int_L \frac{I d\mathbf{l} \times \mathbf{a}_R}{4\pi R^2} \quad (\text{line current})$$

$$\mathbf{H} = \int_S \frac{\mathbf{K} dS \times \mathbf{a}_R}{4\pi R^2} \quad (\text{surface current})$$

$$\mathbf{H} = \int_v \frac{\mathbf{J} dv \times \mathbf{a}_R}{4\pi R^2} \quad (\text{volume current})$$

As an example, let us apply above equation to determine the field due to a *straight* current carrying filamentary conductor of finite length  $AB$ . We assume that the conductor is along the  $z$ -axis with its upper and lower ends respectively subtending angles  $\alpha_1$  and  $\alpha_2$  at  $P$ , the point at which  $\mathbf{H}$  is to be determined. Particular note should be taken of this assumption as the formula to be derived will have to be applied accordingly. If we consider the contribution  $d\mathbf{H}$  at  $P$  due to an element  $d\mathbf{l}$  at  $(0, 0, z)$ ,

$$d\mathbf{H} = \frac{I d\mathbf{l} \times \mathbf{R}}{4\pi R^3}$$

Fig 2.2.2

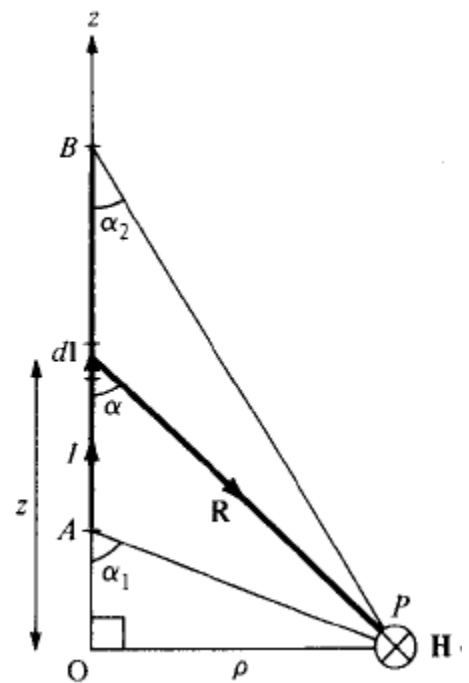

But  $d\mathbf{l} = dz \mathbf{a}_z$  and  $\mathbf{R} = \rho \mathbf{a}_\rho - z \mathbf{a}_z$ , so

$$d\mathbf{l} \times \mathbf{R} = \rho dz \mathbf{a}_\phi$$

Hence,

$$\mathbf{H} = \int \frac{I \rho dz}{4\pi[\rho^2 + z^2]^{3/2}} \mathbf{a}_\phi$$

Letting  $z = \rho \cot \alpha$ ,  $dz = -\rho \operatorname{cosec}^2 \alpha d\alpha$ , and eq. (7.11) becomes

$$\begin{aligned} \mathbf{H} &= -\frac{1}{4\pi} \int_{\alpha_1}^{\alpha_2} \frac{\rho^2 \operatorname{cosec}^2 \alpha d\alpha}{\rho^3 \operatorname{cosec}^3 \alpha} \mathbf{a}_\phi \\ &= -\frac{I}{4\pi\rho} \mathbf{a}_\phi \int_{\alpha_1}^{\alpha_2} \sin \alpha d\alpha \end{aligned}$$

or

$$\mathbf{H} = \frac{I}{4\pi\rho} (\cos \alpha_2 - \cos \alpha_1) \mathbf{a}_\phi$$

This expression is generally applicable for any straight filamentary conductor of finite length. Notice from the above equation that  $\mathbf{H}$  is always along the unit vector  $\mathbf{a}_\phi$  (i.e., along concentric circular paths) irrespective of the length of the wire or the point of interest  $P$ . As special case, when the conductor is *semi-infinite* (with respect to  $P$ ) so that point  $A$  is now at  $O(0, 0, 0)$  while  $B$  is at  $(0, 0, \infty)$ ;  $\alpha_1 = 90^\circ$ ,  $\alpha_2 = 0^\circ$ ,

$$\mathbf{H} = \frac{I}{4\pi\rho} \mathbf{a}_\phi$$

Another special case is when the conductor is *infinite* in length. For this case, point  $A$  is at  $(0, 0, -\infty)$  while  $B$  is at  $(0, 0, \infty)$ ;  $\alpha_1 = 180^\circ$ ,  $\alpha_2 = 0^\circ$ , so the above equation becomes

$$\mathbf{H} = \frac{I}{2\pi\rho} \mathbf{a}_\phi$$

### Ampere's Circuital Law:

Ampere's circuital law states that the line integral of the magnetic field  $H$  (circulation of  $H$ )

Around a closed path is the net current enclosed by this path. Mathematically,

$$\oint \vec{H} \cdot d\vec{l} = I_{enc}$$

The total current  $I_{enc}$  can be written as

$$I_{enc} = \int_S \vec{J} \cdot d\vec{s}$$

By applying Stoke's theorem, we can write

$$\begin{aligned} \oint \vec{H} \cdot d\vec{l} &= \int_S \nabla \times \vec{H} \cdot d\vec{s} \\ \therefore \int_S \nabla \times \vec{H} \cdot d\vec{s} &= \int_S \vec{J} \cdot d\vec{s} \end{aligned}$$

$\therefore \nabla \times \vec{H} = \vec{J}$  Which is the Ampere's law in the point form.

### Applications of Ampere's law:

We illustrate the application of Ampere's Law with some examples.

We compute magnetic field due to an infinitely long thin current carrying conductor as shown in Fig below Using Ampere's Law, we consider the close path to be a circle of radius  $\rho$  as shown in the Fig. below

If we consider a small current element  $Id\vec{l} (= Idz\hat{z})$   $d\vec{H}$  is perpendicular to the plane

Containing both  $d\vec{l}$  and  $\vec{R} (= \rho\hat{a}_\rho)$  therefore only component of  $H$  that will be present is  $H_\phi$

By applying Ampere's law we can write,

$$\vec{H} = \frac{I}{2\pi\rho} \hat{a}_\phi \int_0^{2\pi} H_\phi \rho d\phi = H_\phi \rho 2\pi = I$$

Therefore,  $\vec{H} = \frac{I}{2\pi\rho} \hat{a}_\phi$  this is same as equation.

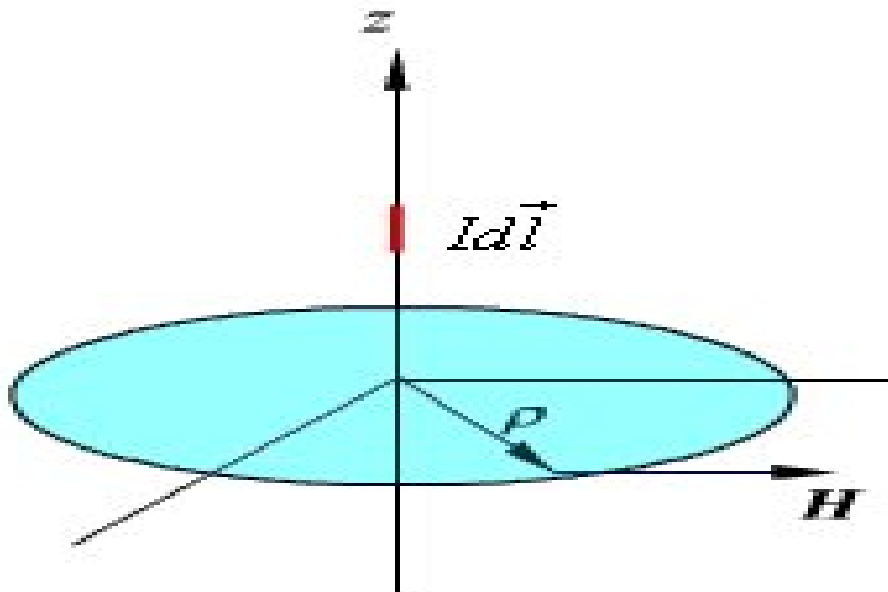

### Magnetic field due to an infinite thin current carrying conductor

We consider the cross section of an infinitely long coaxial conductor, the inner conductor carrying a current  $I$  and outer conductor carrying current  $-I$  as shown in above figure We compute the magnetic field as a function of  $\rho$  as follows

In the region  $0 < \rho < R_1$

$$I_{enc} = I \frac{\rho^2}{R_1^2}$$

$$H_{\phi} = \frac{I_{enc}}{2\pi\rho} = \frac{I\rho}{2\pi a^2}$$

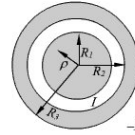

In the region  $R_1 < \rho < R_2$

$$I_{enc} = I$$

$$H_{\phi} = \frac{I}{2\pi\rho}$$

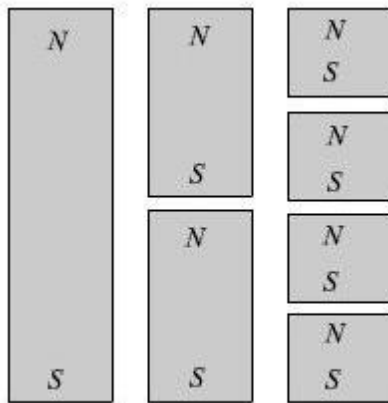

(a)

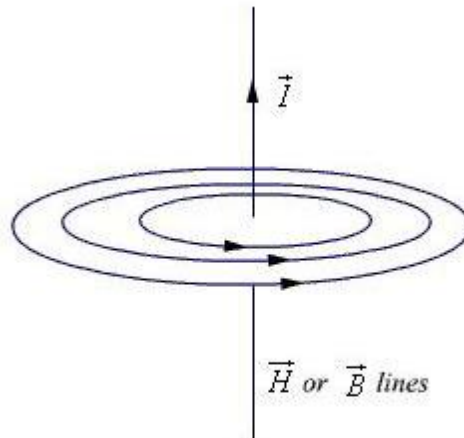

(b)

Similarly if we consider the field/flux lines of a current carrying conductor as shown above figure (b), we find that these lines are closed lines, that is, if we consider a closed surface, the number of flux lines that would leave the surface would be same as the number of flux lines that would enter the surface. From our discussions above, it is evident that for magnetic field,

$$\oint_S \vec{B} \cdot d\vec{s} = 0$$

$$\oint_S \vec{B} \cdot d\vec{s} = \int_V \nabla \cdot \vec{B} dv = 0$$

Hence

$$\nabla \cdot \vec{B} = 0$$

This is the Gauss's law for the magnetic field in point form.

## MAGNETIC FORCES, MATERIALS, AND DEVICES

### INTRODUCTION

Having considered the basic laws and techniques commonly used in calculating magnetic field  $B$  due to current-carrying elements, we are prepared to study the force a magnetic field exerts on charged particles, current elements, and loops. Such a study is important to problems on electrical devices such as ammeters, voltmeters, galvanometers, cyclotrons, plasmas, motors, and magneto hydrodynamic generators. The precise definition of the magnetic field, deliberately sidestepped in the previous chapter, will be given here. The concepts of magnetic moments and dipole will also be considered. Furthermore, we will consider magnetic fields in material media, as opposed to the magnetic fields in vacuum or free space examined in the previous chapter. The results of the preceding chapter need only some modification to account for the presence of materials in a magnetic field. Further discussions will cover inductors, inductances, magnetic energy, and magnetic circuits.

### Magnetic Scalar and Vector Potentials:

In studying electric field problems, we introduced the concept of electric potential that simplified the computation of electric fields for certain types of problems. In the same manner let us relate the magnetic field intensity to a **scalar magnetic potential** and write

$$\vec{H} = -\nabla V_m$$

From Ampere's law, we know that

$$\nabla \times \vec{H} = \vec{J}$$

Therefore

$$\nabla \times (-\nabla V_m) = \vec{J}$$

But using vector identity

### Boundary Condition for Magnetic Fields:

Similar to the boundary conditions in the electro static fields, here we will consider the behavior of  $\vec{B}$  and  $\vec{H}$  at the interface of two different media. In particular, we determine how the tangential and normal components of magnetic fields behave at the boundary of two regions having different permeability. The figure shows the interface between two media having permeabilities  $\mu_1$  and  $\mu_2$ ,  $\hat{a}_z$  being the normal vector from medium 2 to medium 1.

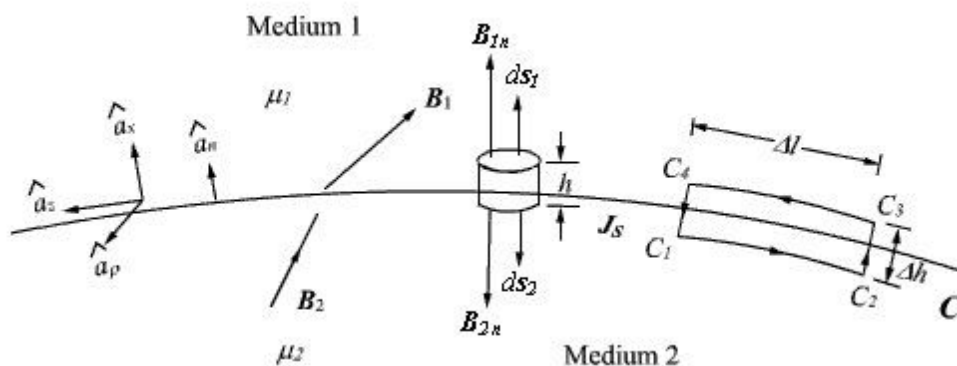

**Figure: Interface between two magnetic media**

To determine the condition for the normal component of the flux density vector  $\vec{B}$ , we consider a small pill box P with vanishingly small thickness  $h$  and having an elementary area

$\Delta S$  for the faces. Over the pill box, we can write

$$\oint_S \vec{B} \cdot d\vec{S} = 0$$

Since  $h \rightarrow 0$ , we can neglect the flux through the sidewall of the pill box.

$$\therefore \int_{\Delta S} \vec{B}_1 \cdot d\vec{S}_1 + \int_{\Delta S} \vec{B}_2 \cdot d\vec{S}_2 = 0$$

$$d\vec{S}_1 = dS \hat{a}_n \quad \text{and} \quad d\vec{S}_2 = dS (-\hat{a}_n)$$

$$\therefore \int_{\Delta S} B_{1n} dS - \int_{\Delta S} B_{2n} dS = 0$$

where

$$B_{1n} = \vec{B}_1 \cdot \hat{a}_n \quad \text{and} \quad B_{2n} = \vec{B}_2 \cdot \hat{a}_n$$

Since  $\Delta S$  is small, we can write

$$(\vec{B}_1 - \vec{B}_2) \Delta S = 0$$

Or,

$$\vec{B}_1 = \vec{B}_2$$

That is, the normal component of the magnetic flux density vector is continuous across the interface.

In vector form,

$$\hat{a}_n \cdot (\vec{B}_1 - \vec{B}_2) = 0$$

To determine the condition for the tangential component for the magnetic field, we consider a closed path C as shown in figure . By applying Ampere's law we can write

$$\oint_C \vec{H} \cdot d\vec{l} = I$$

Since  $h \rightarrow 0$ ,

$$\int_{c_1-c_2} \vec{H} \cdot d\vec{l} + \int_{c_3-c_4} \vec{H} \cdot d\vec{l} = I$$

We have shown in figure , a set of three unit vectors  $\hat{a}_n$ ,  $\hat{a}_t$  and  $\hat{a}_p$  such that they satisfy  $\hat{a}_t = \hat{a}_p \times \hat{a}_n$  (R.H. rule). Here  $\hat{a}_t$  is tangential to the interface and  $\hat{a}_p$  is the vector perpendicular to the surface enclosed by C at the interface

The above equation can be written as

$$\vec{H}_1 \cdot \Delta \hat{a}_t - \vec{H}_2 \cdot \Delta \hat{a}_t = I = J_{sn} \Delta$$

Or,

$$\vec{H}_{1t} - \vec{H}_{2t} = \vec{J}_s$$

i.e., tangential component of magnetic field component is discontinuous across the interface where a free surface current exists.



If  $J_s = 0$ , the tangential magnetic field is also continuous. If one of the medium is a perfect conductor  $J_s$  exists on the surface of the perfect conductor.

In vector form we can write,

$$\begin{aligned} (\vec{H}_1 - \vec{H}_2) \cdot \hat{a}_t \Delta l \\ = (\vec{H}_1 - \vec{H}_2) \cdot (\hat{a}_\rho \times \hat{a}_z) \Delta l \\ = J_{s \Delta l} = \vec{J}_s \cdot \hat{a}_\rho \Delta l \end{aligned}$$

Therefore,

$$\hat{a}_z \times (\vec{H}_1 - \vec{H}_2) = \vec{J}_s$$

### **Magnetic forces and materials:**

In our study of static fields so far, we have observed that static electric fields are produced by electric charges, static magnetic fields are produced by charges in motion or by steady current. Further, static electric field is a conservative field and has no curl, the static magnetic field is continuous and its divergence is zero. The fundamental relationships for static electric fields among the field quantities can be summarized as:

$$\nabla \times \vec{E} = 0$$

$$\nabla \cdot \vec{D} = \rho_v$$

For a linear and isotropic medium,

$$\vec{D} = \epsilon \vec{E}$$

Similarly for the magnetostatic case

$$\nabla \cdot \vec{B} = 0$$

$$\nabla \times \vec{H} = \vec{J}$$

$$\vec{B} = \mu \vec{H}$$

It can be seen that for static case, the electric field vectors and magnetic field vectors form separate pairs.

## MODULE-III

### INDUCTION:

In electromagnetism and electronics, inductance is the property of a conductor by which a change in current flowing through it induces (creates) a voltage (electromotive force) in both the conductor itself (self-inductance) and in any nearby conductors (mutual inductance).

These effects are derived from two fundamental observations of physics: First, that a steady current creates a steady magnetic field (Oersted's law), and second, that a time-varying magnetic field induces voltage in nearby conductors (Faraday's law of induction). According to Lenz's law, a changing electric current through a circuit that contains inductance induces a proportional voltage, which opposes the change in current (self-inductance). The varying field in this circuit may also induce an e.m.f. in neighbouring circuits (mutual inductance).

Faraday's law of Induction:

Faraday's law of induction is a basic law of electromagnetism predicting how a magnetic field will interact with an electric circuit to produce an electromotive force (EMF)-a phenomenon called electromagnetic induction. It is the fundamental operating principle of transformers, inductors, and many types of electrical motors, generators and solenoids.

The most widespread version of Faraday's law states:

The induced electromotive force in any closed circuit is equal to the negative of the time rate of change of the magnetic flux enclosed by the circuit.

Faraday's law of induction makes use of the magnetic flux  $\Phi_B$  through a hypothetical surface  $\Sigma$  whose boundary is a wire loop. Since the wire loop may be moving, we write  $\Sigma(t)$  for the surface. The magnetic flux is defined by a surface integral:

$$\Phi_B = \iint_{\Sigma(t)} \mathbf{B}(\mathbf{r}, t) \cdot d\mathbf{A} ,$$

where  $d\mathbf{A}$  is an element of surface area of the moving surface  $\Sigma(t)$ ,  $\mathbf{B}$  is the magnetic field (also called "magnetic flux density"), and  $\mathbf{B} \cdot d\mathbf{A}$  is a vector dot product (the infinitesimal amount of magnetic flux). In more visual terms, the magnetic flux through the wire loop is proportional to the number of magnetic flux lines that pass through the loop.

When the flux changes—because  $\mathbf{B}$  changes, or because the wire loop is moved or deformed, or both—Faraday's law of induction says that the wire loop acquires an EMF,  $\mathcal{E}$ , defined as the energy available from a unit charge that has travelled once around the wire loop. Equivalently, it is the voltage that would be measured by cutting the wire to create an open circuit, and attaching a voltmeter to the leads.

Faraday's law states that the EMF is also given by the rate of change of the magnetic flux:

$$\mathcal{E} = -\frac{d\Phi_B}{dt}$$

Where  $\varepsilon$  is the electromotive force (EMF) and  $\Phi_B$  is the magnetic flux. The direction of the electromotive force is given by Lenz's law.

For a tightly wound coil of wire, composed of  $N$  identical turns, each with the same  $\Phi_B$ , Faraday's law of induction states that

$$\varepsilon = -N \frac{d\Phi_B}{dt}$$

where  $N$  is the number of turns of wire and  $\Phi_B$  is the magnetic flux through a *single* loop.

Self Inductance:

We do not necessarily need two circuits in order to have inductive effects. Consider a single conducting circuit around which a current  $I$  is flowing. This current generates a magnetic field  $B$  which gives rise to a magnetic flux  $\Phi$  linking the circuit. We expect the flux  $\Phi$  to be directly proportional to the current  $I$ , given the linear nature of the laws of magnetostatics, and the definition of magnetic flux. Thus, we can write

$$\Phi = LI$$

where the constant of proportionality  $L$  is called the *self inductance* of the circuit. Like mutual inductance, the self inductance of a circuit is measured in units of henries, and is a purely geometric quantity, depending only on the shape of the circuit and number of turns in the circuit.

If the current flowing around the circuit changes by an amount  $dI$  in a time interval  $dt$  then the magnetic flux linking the circuit changes by an amount  $d\Phi = LdI$  in the same time interval. According to Faraday's law, an emf

$$\varepsilon = \frac{d\phi}{dt}$$

is generated around the circuit. Since  $d\Phi = LdI$ , this emf can also be written

$$\varepsilon = -L \frac{dI}{dt}$$

Thus, the emf generated around the circuit due to its own current is directly proportional to the rate at which the current changes. Lenz's law, and common sense, demand that if the current is increasing then the emf should always act to reduce the current, and vice versa. This is easily appreciated, since if the emf acted to increase the current when the current was increasing then we would clearly get an unphysical positive feedback effect in which the current continued to increase without limit. It follows, from the above, that the self inductance  $L$  of a circuit is necessarily a positive number. This is not the case for mutual inductances, which can be either positive or negative.

Consider a solenoid of length  $l$  and cross-sectional area  $A$ . Suppose that the solenoid has  $N$  turns. When a current  $I$  flows in the solenoid, a uniform axial field of magnitude

$$B = \frac{\mu_0 NI}{l}$$

is generated in the core of the solenoid. The field-strength outside the core is negligible. The magnetic flux linking a single turn of the solenoid is  $\Phi=BA$ . Thus, the magnetic flux linking all  $N$  turns of the solenoid is

$$\Phi=NBA=\frac{\mu_0 N^2 AI}{l}$$

the self inductance of the solenoid is given by, which reduces to  $L = \frac{\phi}{I}$

$$L=\frac{\mu_0 N^2 A}{l}$$

Note that  $L$  is positive. Furthermore,  $L$  is a geometric quantity depending only on the dimensions of the solenoid, and the number of turns in the solenoid.

Engineers like to reduce all pieces of electrical apparatus, no matter how complicated, to an *equivalent circuit* consisting of a network of just *four* different types of component. These four basic components are *emfs*, *resistors*, *capacitors*, and *inductors*. An inductor is simply a pure self inductance, and is usually represented a little solenoid in circuit diagrams. In practice, inductors generally consist of short air-cored solenoids wound from enamelled copper wire.

## Mutual Inductance

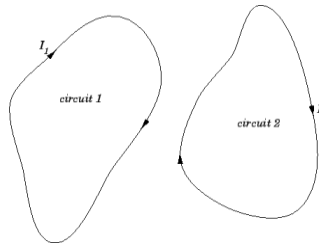

*Two inductively coupled circuits.*

Consider two arbitrary conducting circuits, labelled 1 and 2. Suppose that  $I_1$  is the instantaneous current flowing around circuit 1. This current generates a magnetic field  $B_1$  which links the second circuit, giving rise to a magnetic flux  $\Phi_1$  through that circuit. If the current  $I_2$  doubles, then the magnetic field  $B_2$  doubles in strength at all points in space, so the magnetic flux  $\Phi_2$  through the second circuit also doubles. This conclusion follows from the *linearity* of the laws of magneto statics, plus the definition of magnetic flux. Furthermore, it is obvious that the flux through the second circuit is zero whenever the current flowing around the first circuit is zero. It follows that the flux  $\Phi_2$  through the second circuit is *directly proportional* to the current  $I_1$  flowing around the first circuit. Hence, we can write

$$\phi_2 = M_{21}I_1$$

where the constant of proportionality  $M_{21}$  is called the *mutual inductance* of circuit 2 with respect to circuit 1. Similarly, the flux  $\Phi_1$  through the first circuit due to the instantaneous current  $I_2$  flowing around the second circuit is directly proportional to that current, so we can write

$$\phi_1 = M_{12}I_2$$

where  $M_{12}$  is the *mutual inductance* of circuit 1 with respect to circuit 2. It is possible to demonstrate mathematically that  $M_{12}=M_{21}$ . In other words, the flux linking circuit 2 when a certain current flows around circuit 1 is exactly the same as the flux linking circuit 1 when the same current flows around circuit 2. This is true irrespective of the size, number of turns, relative position, and relative orientation of the two circuits. Because of this, we can write

$$M_{12} = M_{21} = M$$

where  $M$  is termed the *mutual inductance* of the two circuits. Note that  $M$  is a purely geometric quantity, depending only on the size, number of turns, relative position, and relative orientation of the two circuits. The SI units of mutual inductance are called *Henries* (H). One henry is equivalent to a volt-second per ampere

$$1 \text{ H} \equiv 1 \text{ V s A}^{-1}.$$

It turns out that a henry is a rather unwieldy unit. The mutual inductances of the circuits typically encountered in laboratory experiments are measured in milli-henries. Suppose that the current flowing around circuit 1 changes by an amount  $dI_1$  in a time interval  $dt$ . The flux linking circuit 2

$$d\phi_2 = MdI_1$$

changes by an amount in the same time interval. According to Faraday's law, an emf

$$\varepsilon_2 = -\frac{d\phi_2}{dt}$$

is generated around the second circuit due to the changing magnetic flux linking that circuit. Since,  $d\phi_2=MdI_1$ , this emf can also be written

$$\varepsilon_2 = -M \frac{dI_1}{dt}$$

Thus, the emf generated around the second circuit due to the current flowing around the first circuit is directly proportional to the rate at which that current changes.

Likewise, if the current  $I_2$  flowing around the second circuit changes by an amount  $dI_2$  in a time interval  $dt$  then the emf generated around the first circuit is

$$\varepsilon_1 = -M \frac{dI_2}{dt}$$

Note that there is no direct physical coupling between the two circuits. The coupling is due entirely to the magnetic field generated by the currents flowing around the circuits.

As a simple example, suppose that two insulated wires are wound on the same cylindrical former, so as to form two solenoids sharing a common air-filled core. Let  $l$  be the length of the core,  $A$  the cross-sectional area of the core,  $N_1$  the number of times the first wire is wound around the core, and  $N_2$  the number of times the second wire is wound around the core. If a current  $I_1$  flows around the first wire then a uniform axial magnetic field of strength  $B_1=\mu_0N_1I_1/l$  is generated in the core. The magnetic field in the region outside the core is of negligible magnitude.

The flux linking a single turn of the second wire is  $B_1A$ . Thus, the flux linking all  $N_2$  turns of the second wire is.

$$\Phi = N_2 B_1 A = \frac{\mu_0 N_1 N_2 A I_1}{l}$$

The mutual inductance of the second wire with respect to the first is

$$M_{21} = \frac{\phi_2}{I_1} = \frac{\mu_0 N_1 N_2 A}{l}$$

Now, the flux linking the second wire when a current  $I_2$  flows in the first wire is  $\Phi_1 = N_1 B_2 A$ , where  $B_2 = \mu_0 N_2 I_2 / l$  is the associated magnetic field generated in the core. It follows that the mutual inductance of the first wire with respect to the second is

$$M_{12} = \frac{\phi_1}{I_2} = \frac{\mu_0 N_1 N_2 A}{l}$$

Thus, the mutual inductance of the two wires is given by

$$M = \frac{\mu_0 N_1 N_2 A}{l}$$

As described previously,  $M$  is a geometric quantity depending on the dimensions of the core, and the manner in which the two wires are wound around the core, but not on the actual currents flowing through the wires.

### Maxwell's Equations

Symbols Used		
$E$ = Electric field	$\rho$ = charge density	$i$ = electric current
$B$ = Magnetic field	$\epsilon_0$ = permittivity	$J$ = current density
$D$ = Electric displacement	$\mu_0$ = permeability	$c$ = speed of light
$H$ = Magnetic field strength	$M$ = Magnetization	$P$ = Polarization

Name	Integral equations	Differential equations
Gauss's law	$\oiint_{\partial\Omega} \mathbf{E} \cdot d\mathbf{S} = \frac{1}{\epsilon_0} \iiint_{\Omega} \rho dV$	$\nabla \cdot \mathbf{E} = \frac{\rho}{\epsilon_0}$
Gauss's law for magnetism	$\oiint_{\partial\Omega} \mathbf{B} \cdot d\mathbf{S} = 0$	$\nabla \cdot \mathbf{B} = 0$
Maxwell-Faraday equation (Faraday's law of induction)	$\oint_{\partial\Sigma} \mathbf{E} \cdot d\boldsymbol{\ell} = -\frac{d}{dt} \iint_{\Sigma} \mathbf{B} \cdot d\mathbf{S}$	$\nabla \times \mathbf{E} = -\frac{\partial \mathbf{B}}{\partial t}$
Ampère's circuital law (with Maxwell's addition)	$\oint_{\partial\Sigma} \mathbf{B} \cdot d\boldsymbol{\ell} = \mu_0 \iint_{\Sigma} \mathbf{J} \cdot d\mathbf{S} + \mu_0 \epsilon_0 \frac{d}{dt} \iint_{\Sigma} \mathbf{E} \cdot d\mathbf{S}$	$\nabla \times \mathbf{B} = \mu_0 \left( \mathbf{J} + \epsilon_0 \frac{\partial \mathbf{E}}{\partial t} \right)$

where the universal constants appearing in the equations are

- the permittivity of free space  $\epsilon_0$  and
- the permeability of free space  $\mu_0$ .

In the differential equations, a *local* description of the fields,

- the nabla symbol  $\nabla$  denotes the three-dimensional gradient operator, and from it
- the divergence operator is  $\nabla \cdot$
- the curl operator is  $\nabla \times$ .

The sources are taken to be

- the electric charge density (charge per unit volume)  $\rho$  and
- the electric current density (current per unit area)  $\mathbf{J}$ .

In the integral equations; a description of the fields within a region of space,

- $\Omega$  is any fixed volume with boundary surface  $\partial\Omega$ , and

- $\Sigma$  is any fixed open surface with boundary curve  $\partial\Sigma$ ,
- $\oiint_{\partial\Omega}$  is a surface integral over the surface  $\partial\Omega$  (the oval indicates the surface is closed and not open),
- $\iiint_{\Omega}$  is a volume integral over the volume  $\Omega$ ,
- $\iint_{\Sigma}$  is a surface integral over the surface  $\Sigma$ ,
- $\oint_{\partial\Sigma}$  is a line integral around the curve  $\partial\Sigma$  (the circle indicates the curve is closed).

Here "fixed" means the volume or surface do not change in time. Although it is possible to formulate Maxwell's equations with time-dependent surfaces and volumes, this is not actually necessary: the equations are correct and complete with time-independent surfaces. The sources are correspondingly the total amounts of charge and current within these volumes and surfaces, found by integration.

- The volume integral of the total charge density  $\rho$  over any fixed volume  $\Omega$  is the *total* electric charge contained in  $\Omega$ :

$$Q = \iiint_{\Omega} \rho \, dV ,$$

where  $dV$  is the differential volume element, and

- the *net* electrical current is the surface integral of the electric current density  $\mathbf{J}$ , passing through any open fixed surface  $\Sigma$ :

$$I = \iint_{\Sigma} \mathbf{J} \cdot d\mathbf{S} ,$$

where  $d\mathbf{S}$  denotes the differential vector element of surface area  $S$  normal to surface  $\Sigma$ . (Vector area is also denoted by  $\mathbf{A}$  rather than  $\mathbf{S}$ , but this conflicts with the magnetic potential, a separate vector field).

The "total charge or current" refers to including free and bound charges, or free and bound currents.

### Gauss's law

Gauss's law describes the relationship between a static electric field and the electric charges that cause it: The static electric field points away from positive charges and towards negative charges. In the field line description, electric field lines begin only at positive electric charges and end only at negative electric charges. 'Counting' the number of field lines passing through a closed surface, therefore, yields the total charge (including bound charge due to polarization of material) enclosed by that surface divided by dielectricity of free space (the vacuum permittivity). More technically, it relates the electric flux through any hypothetical closed "Gaussian surface" to the enclosed electric charge.



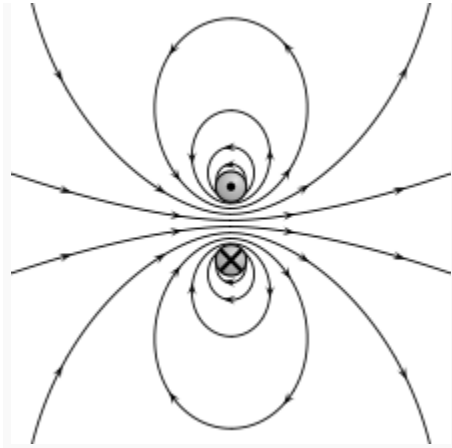

Gauss's law for magnetism: magnetic field lines never begin nor end but form loops or extend to infinity as shown here with the magnetic field due to a ring of current.

### **Gauss's law for magnetism**

Gauss's law for magnetism states that there are no "magnetic charges" (also called magnetic monopoles), analogous to electric charges.<sup>[3]</sup> Instead, the magnetic field due to materials is generated by a configuration called a dipole. Magnetic dipoles are best represented as loops of current but resemble positive and negative 'magnetic charges', inseparably bound together, having no net 'magnetic charge'. In terms of field lines, this equation states that magnetic field lines neither begin nor end but make loops or extend to infinity and back. In other words, any magnetic field line that enters a given volume must somewhere exit that volume. Equivalent technical statements are that the sum total magnetic flux through any Gaussian surface is zero, or that the magnetic field is a solenoidal vector field.

### **Faraday's law**

The Maxwell-Faraday's equation version of Faraday's law describes how a time varying magnetic field creates ("induces") an electric field.<sup>[3]</sup> This dynamically induced electric field has closed field lines just as the magnetic field, if not superposed by a static (charge induced) electric field. This aspect of electromagnetic induction is the operating principle behind many electric generators: for example, a rotating bar magnet creates a changing magnetic field, which in turn generates an electric field in a nearby wire.

### **Ampère's law with Maxwell's addition**

Ampère's law with Maxwell's addition states that magnetic fields can be generated in two ways: by electrical current (this was the original "Ampère's law") and by changing electric fields (this was "Maxwell's addition").

Maxwell's addition to Ampère's law is particularly important: it shows that not only does a changing magnetic field induce an electric field, but also a changing electric field induces a magnetic field.<sup>[3][4]</sup> Therefore, these equations allow self-sustaining "electromagnetic waves" to travel through empty space (see electromagnetic wave equation).

The speed calculated for electromagnetic waves, which could be predicted from experiments on charges and currents,<sup>[note 2]</sup> exactly matches the speed of light; indeed, light is one form

of electromagnetic radiation (as are X-rays, radio waves, and others). Maxwell understood the connection between electromagnetic waves and light in 1861, thereby unifying the theories of electromagnetism and optics.

### Equation of continuity.

The continuity equation can be derived by taking the divergence of

$$\nabla \times \vec{H} = \frac{\partial \vec{D}}{\partial t} + \vec{J}$$

Where  $\vec{H}$  is the magnetic field, in amperes per meter (A/m) and  $\vec{D}$  is the electric flux density, in coulombs per meter squared (Coul/m<sup>2</sup>).

And also using,  $\nabla \cdot \vec{D} = \rho$ , we get

$$\nabla \cdot \vec{J} + \frac{\partial \rho}{\partial t} = 0$$

This equation states that charge is conserved, or that current is continuous, since  $\nabla \cdot \vec{J}$  represents the outflow of current at a point, and  $\frac{\partial \rho}{\partial t}$  represents the charge build up with time at the same point. It is this result that led Maxwell to the conclusion that the displacement current density  $\frac{\partial \vec{D}}{\partial t}$  was necessary in (1.1b), which can be seen by taking the divergence of this equation.

### Concept of Displacement Current.

In electromagnetism, displacement current is a quantity appearing in Maxwell's equations that is defined in terms of the rate of change of electric displacement field. Displacement current has the units of electric current density, and it has an associated magnetic field just as actual currents do. However it is not an electric current of moving charges, but a time-varying electric field. In materials, there is also a contribution from the slight motion of charges bound in atoms, dielectric polarization.

The electric displacement field is defined as:

$$D = \epsilon_0 E + P$$

Where:

$\epsilon_0$  is the permittivity of free space

$\mathbf{E}$  is the electric field intensity

$\mathbf{P}$  is the polarization of the medium

Differentiating this equation with respect to time defines the *displacement current density*, which therefore has two components in a dielectric:

$$J_D = \epsilon_0 \frac{\partial E}{\partial t} + \frac{\partial P}{\partial t}$$

The first term on the right hand side is present in material media and in free space. It doesn't necessarily come from any actual movement of charge, but it does have an associated magnetic field, just as does a current due to charge motion. Some authors apply the name displacement current to the first term by itself.

The second term on the right hand side comes from the change in polarization of the individual molecules of the dielectric material. Polarization results when the charges in molecules have moved from a position of exact cancellation under the influence of an applied electric field. The positive and negative charges in molecules separate, causing an increase in the state of polarization  $\mathbf{P}$ . A changing state of polarization corresponds to charge movement and so is equivalent to a current.

This polarization is the displacement current as it was originally conceived by Maxwell. Maxwell made no special treatment of the vacuum, treating it as a material medium. For Maxwell, the effect of  $\mathbf{P}$  was simply to change the relative permittivity  $\epsilon_r$  in the relation  $\mathbf{D} = \epsilon_r \epsilon_0 \mathbf{E}$ .

The modern justification of displacement current is explained below.

### Isotropic dielectric case

In the case of a very simple dielectric material the constitutive relation holds:

$$D = \epsilon E$$

where the permittivity  $\epsilon = \epsilon_0 \epsilon_r$ ,

- $\epsilon_r$  is the relative permittivity of the dielectric and
- $\epsilon_0$  is the electric constant.

In this equation the use of  $\epsilon$  accounts for the polarization of the dielectric.

The scalar value of displacement current may also be expressed in terms of electric flux:

$$I_D = \epsilon \frac{\partial \phi_E}{\partial t}$$

The forms in terms of  $\epsilon$  are correct only for linear isotropic materials. More generally  $\epsilon$  may be replaced by a tensor, may depend upon the electric field itself, and may exhibit frequency dependence (dispersion).

For a linear isotropic dielectric, the polarization  $\mathbf{P}$  is given by:

$$P = \epsilon_0 \chi_e E = \epsilon_0 (\epsilon_r - 1) E$$

Where  $\chi_e$  is known as the electric susceptibility of the dielectric. Note that:

$$\epsilon = \epsilon_r \epsilon_0 = (1 + \chi_e) \epsilon_0$$

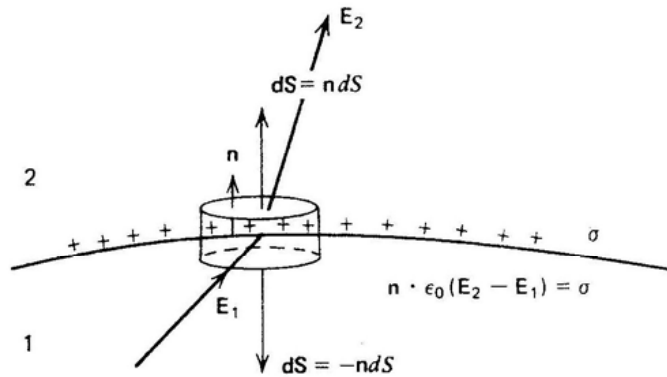

Figure 2-19 Gauss's law applied to a differential sized pill-box surface enclosing some surface charge shows that the normal component of  $\epsilon_0 \mathbf{E}$  is discontinuous in the surface charge density.

### Electromagnetic Boundary Conditions:

#### 1. Gauss' Continuity Condition

$$\oint_S \epsilon_0 \vec{E} \cdot \vec{da} = \int_S \sigma_s dS \Rightarrow \epsilon_0 (E_{2n} - E_{1n}) dS = \sigma_s dS$$

$$\epsilon_0 (E_{2n} - E_{1n}) = \sigma_s \Rightarrow \vec{n} \cdot [\epsilon_0 (\vec{E}_2 - \vec{E}_1)] = \sigma_s$$

#### 2. Continuity of Tangential $\vec{E}$

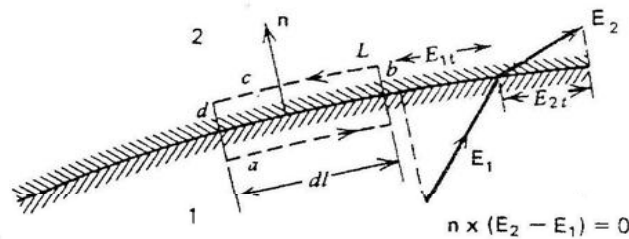

(a)

Figure 3-12 (a) Stokes' law applied to a line integral about an interface of discontinuity shows that the tangential component of electric field is continuous across the boundary.

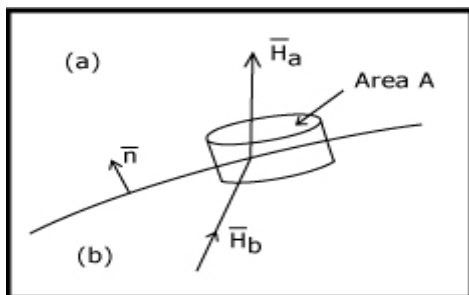

$$\oint_C \vec{E} \cdot \vec{dS} = (E_{1t} - E_{2t}) dl = 0 \Rightarrow E_{1t} - E_{2t} = 0$$

$$\vec{n} \times (\vec{E}_1 - \vec{E}_2) = 0 \quad \text{Equivalent to } \Phi_1 = \Phi_2 \text{ along boundary.}$$

### 3. Normal $\vec{H}$

$$\oint_s \mu_0 \vec{H} \cdot \vec{da} = 0$$

$$\mu_0 (H_{an} - H_{bn}) A = 0$$

$$H_{an} = H_{bn}$$

$$\vec{n} \cdot [\vec{H}_a - \vec{H}_b] = 0$$

### 4. Tangential $\vec{H}$

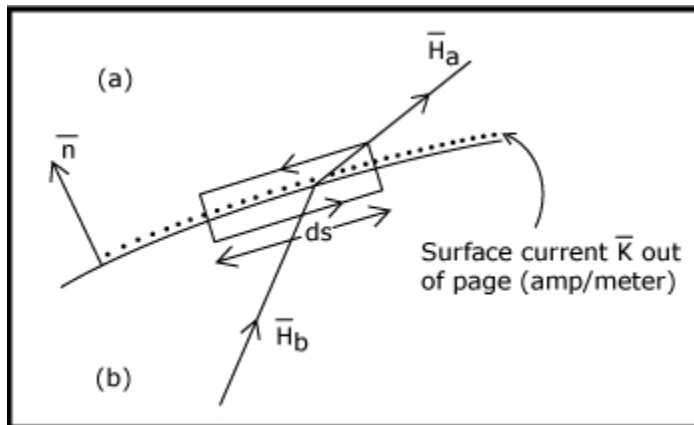

$$\oint_c \vec{H} \cdot \vec{ds} = \int_s \vec{J} \cdot \vec{da} + \frac{d}{dt} \int_s \epsilon_0 \vec{E} \cdot \vec{da}$$

$$H_{bt} ds - H_{at} ds = K ds$$

$$H_{bt} - H_{at} = K$$

$$\vec{n} \times [\vec{H}_a - \vec{H}_b] = \vec{K}$$

### 5. Conservation of Charge Boundary Condition

$$\oint_s \vec{J} \cdot \vec{da} + \frac{d}{dt} \int_v \rho dV$$

$$\vec{n} \cdot [\vec{J}_a - \vec{J}_b] + \frac{\partial}{\partial t} \rho_s = 0$$

### Poynting's Theorem:

The Poynting theorem is one of the most important results in EM theory. It tells us the power flowing in an electromagnetic field.

John Henry Poynting was the developer and eponym of the Poynting vector, which describes the direction and magnitude of electromagnetic energy flow and is used in the Poynting theorem, a statement about energy conservation for electric and magnetic fields. This work was first published in 1884. He performed a measurement of Newton's gravitational constant by innovative means during 1893. In 1903 he was the first to realize that the Sun's radiation can draw in small particles towards it. This was later coined the Poynting-Robertson effect.

$$\nabla \times \bar{E} = -\frac{\partial \bar{B}}{\partial t}$$

$$\nabla \times \bar{H} = \bar{J} + \frac{\partial \bar{D}}{\partial t}$$

From these we obtain

$$\bar{H} \cdot (\nabla \times \bar{E}) = -\bar{H} \cdot \frac{\partial \bar{B}}{\partial t}$$

$$\bar{E} \cdot (\nabla \times \bar{H}) = \bar{J} \cdot \bar{E} + \bar{E} \cdot \frac{\partial \bar{D}}{\partial t}$$

Subtract, and use the following vector identity:

$$\bar{H} \cdot (\nabla \times \bar{E}) - \bar{E} \cdot (\nabla \times \bar{H}) = \nabla \cdot (\bar{E} \times \bar{H})$$

We then have:

$$\nabla \cdot (\bar{E} \times \bar{H}) = -\bar{J} \cdot \bar{E} - \bar{H} \cdot \frac{\partial \bar{B}}{\partial t} - \bar{E} \cdot \frac{\partial \bar{D}}{\partial t}$$

Next, assume that Ohm's law applies for the electric current:

$$\bar{J} = \sigma \bar{E}$$

$$\Rightarrow \nabla \cdot (\bar{E} \times \bar{H}) = -\sigma (\bar{E} \cdot \bar{E}) - \bar{H} \cdot \frac{\partial \bar{B}}{\partial t} - \bar{E} \cdot \frac{\partial \bar{D}}{\partial t}$$

$$\Rightarrow \nabla \cdot (\bar{E} \times \bar{H}) = -\sigma |\bar{E}|^2 - \bar{H} \cdot \frac{\partial \bar{B}}{\partial t} - \bar{E} \cdot \frac{\partial \bar{D}}{\partial t}$$

From calculus (chain rule), we have that

$$\bar{E} \cdot \frac{\partial \bar{D}}{\partial t} = \epsilon \left( \bar{E} \cdot \frac{\partial \bar{E}}{\partial t} \right) = \epsilon \frac{1}{2} \frac{\partial}{\partial t} (\bar{E} \cdot \bar{E})$$

$$\bar{H} \cdot \frac{\partial \bar{B}}{\partial t} = \mu \left( \bar{H} \cdot \frac{\partial \bar{H}}{\partial t} \right) = \mu \frac{1}{2} \frac{\partial}{\partial t} (\bar{H} \cdot \bar{H})$$

Hence we have

$$\nabla \cdot (\bar{E} \times \bar{H}) = -\sigma |\bar{E}|^2 - \mu \frac{1}{2} \frac{\partial}{\partial t} (\bar{H} \cdot \bar{H}) - \epsilon \frac{1}{2} \frac{\partial}{\partial t} (\bar{E} \cdot \bar{E})$$

This may be written as

$$\nabla \cdot (\bar{E} \times \bar{H}) = -\sigma |\bar{E}|^2 - \frac{\partial}{\partial t} \left( \frac{1}{2} \mu |\bar{H}|^2 \right) - \frac{\partial}{\partial t} \left( \frac{1}{2} \epsilon |\bar{E}|^2 \right)$$

Final differential (point) form of the Poynting theorem:

$$\nabla \cdot (\bar{E} \times \bar{H}) = -\sigma |\bar{E}|^2 - \frac{\partial}{\partial t} \left( \frac{1}{2} \mu |\bar{H}|^2 \right) - \frac{\partial}{\partial t} \left( \frac{1}{2} \varepsilon |\bar{E}|^2 \right)$$

### Time-Harmonic EM Fields:

In linear media the time-harmonic dependence of the sources gives rise to fields which, once having reached the steady state, also vary sinusoidally in time. However, time-harmonic analysis is important not only because many electromagnetic systems operate with signals that are practically harmonic, but also because arbitrary periodic time functions can be expanded into Fourier series of harmonic sinusoidal components while transient nonperiodic functions can be expressed as Fourier integrals. Thus, since the Maxwell's equations are linear differential equations, the total fields can be synthesized from its Fourier components.

Analytically, the time-harmonic variation is expressed using the complex exponential notation based on Euler's formula, where it is understood that the physical fields are obtained by taking the real part, whereas their imaginary part is discarded. For example, an electric field with time-harmonic dependence given by  $\cos(\omega t + \phi)$ , where  $\omega$  is the angular frequency, is expressed as

$$\bar{E} = \text{Re} \{ \bar{E} e^{j\omega t} \} = \frac{1}{2} (\bar{E} e^{j\omega t} + (\bar{E} e^{j\omega t})^*) = \bar{E}_0 \cos(\omega t + \phi)$$

where  $\bar{E}$  is the complex phasor,

$$\bar{E} = \bar{E}_0 e^{j\phi}$$

of amplitude  $E_0$  and phase  $\phi$ , which will in general be a function of the angular frequency and coordinates. The asterisk \* indicates the complex conjugate, and  $\text{Re} \{ \}$  represents the real part of what is in curly brackets.

Maxwell's equations for time-harmonic fields:

Assuming  $e^{j\omega t}$  time dependence, we can get the phasor form or time-harmonic form of Maxwell's equations simply by changing the operator  $\partial/\partial t$  to the factor  $j\omega$  in and eliminating the factor  $e^{j\omega t}$ . Maxwell's equations in differential and integral forms for time-harmonic fields are given below.

Differential form of Maxwell's equations for time-harmonic fields

$$\nabla \cdot \bar{D} = \rho \quad (\text{Gauss' law})$$

$$\nabla \cdot \bar{D} = \rho \quad (\text{Gauss' law})$$

$$\nabla \cdot \bar{B} = 0 \quad (\text{Gauss' law for magnetic fields})$$

$$\nabla \times \bar{E} = -j\omega \bar{B} \quad (\text{Faraday's law})$$

$$\nabla \times \bar{H} = \bar{J} + j\omega \bar{D} \quad (\text{Generalized Ampère's law})$$

Integral form of Maxwell's equations for time harmonic fields:

$$\oint_S \bar{D} \cdot d\bar{S} = Q_r \quad (\text{Gauss' Law})$$

$$\oint_S \bar{B} \cdot d\bar{S} = 0 \quad (\text{Gauss' Law for magnetic field})$$

$$\oint_{\Gamma} \bar{E} \cdot d\bar{l} = -j\omega \int_S \bar{B} \cdot d\bar{S} \quad (\text{Faraday's Law})$$

$$\oint_{\Gamma} \bar{H} \cdot d\bar{l} = \int_S (\bar{J} + j\omega \bar{D}) \cdot d\bar{S} \quad (\text{Generalised Ampere's Law})$$

## Plane Wave Propagation & Plane wave solution.

In the physics of wave propagation, a plane wave (also spelled planewave) is a constant-frequency wave whose wavefronts (surfaces of constant phase) are infinite parallel planes of constant peak-to-peak amplitude normal to the phase velocity vector.

It is not possible in practice to have a true plane wave; only a plane wave of infinite extent will propagate as a plane wave. However, many waves are approximately plane waves in a localized region of space. For example, a localized source such as an antenna produces a field that is approximately a plane wave far from the antenna in its far-field region. Similarly, if the length scales are much longer than the wave's wavelength, as is often the case for light in the field of optics, one can treat the waves as light rays which correspond locally to plane waves.

Mathematical formalisms:

Two functions that meet the above criteria of having a constant frequency and constant amplitude are the sine and cosine functions. One of the simplest ways to use such a sinusoid involves defining it along the direction of the x-axis. The equation below, which is illustrated toward the right, uses the cosine function to represent a plane wave travelling in the positive x direction.

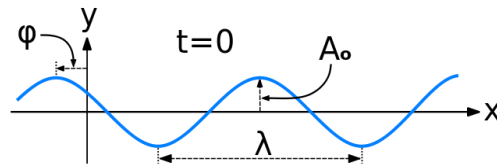

In the above equation:

- $A(x, t)$  is the magnitude or disturbance of the wave at a given point in space and time. An example would be to let  $A(x, t)$  represent the variation of air pressure relative to the norm in the case of a sound wave.
- $A_0$  is the amplitude of the wave which is the peak magnitude of the oscillation.
- $k$  is the wave's wave number or more specifically the *angular* wave number and equals  $2\pi/\lambda$ , where  $\lambda$  is the wavelength of the wave.
- $k$  has the units of radians per unit distance and is a measure of how rapidly the disturbance changes over a given distance at a particular point in time.
- $x$  is a point along the x-axis.  $y$  and  $z$  are not part of the equation because the wave's magnitude and phase are the same at every point on any given  $y$ - $z$  plane. This equation defines what that magnitude and phase are.
- $\omega$  is the wave's angular frequency which equals  $2\pi/T$ , where  $T$  is the period of the wave.  $\omega$  has the units of radians per unit time and is a measure of how rapidly the disturbance changes over a given length of time at a particular point in space.
- $t$  is a given point in time
- $\varphi$  is the phase shift of the wave and has the units of radians. Note that a positive phase shift, at a given moment of time, shifts the wave in the negative x-axis direction. A phase shift of  $2\pi$  radians shifts it exactly one wavelength.



Other formalisms which directly use the wave's wavelength  $\lambda$ , period  $T$ , frequency  $f$  and velocity  $c$  are below.

$$A = A_0 \cos[2\pi(x/\lambda - t/T) + \varphi]$$

$$A = A_0 \cos[2\pi(x/\lambda - ft) + \varphi]$$

$$A = A_0 \cos[(2\pi/\lambda)(x - ct) + \varphi]$$

To appreciate the equivalence of the above set of equations note that  $f = 1/T$  and  $c = \lambda/T = \omega/k$

### Arbitrary direction

A more generalized form is used to describe a plane wave traveling in an arbitrary direction. It uses vectors in combination with the vector dot product.

$$A(\mathbf{r}, t) = A_0 \cos(\mathbf{k} \cdot \mathbf{r} - \omega t + \varphi)$$

here:

- $\mathbf{k}$  is the wave vector which only differs from a wave number in that it has a direction as well as a magnitude. This means that,  $|\mathbf{k}| = k = 2\pi/\lambda$ . The direction of the wave vector is ordinarily the direction that the plane wave is travelling, but it can differ slightly in an anisotropic medium.
- $\cdot$  is the vector dot product.
- $\mathbf{r}$  is the position vector which defines a point in three-dimensional space.

### Complex exponential form

Many choose to use a more mathematically versatile formulation that utilizes the complex number plane. It requires the use of the natural exponent  $e$  and the imaginary number  $i$ .

$$\mathbf{u}(\mathbf{r}, t) = A_0 e^{i(\mathbf{k} \cdot \mathbf{r} - \omega t + \varphi)}$$

To appreciate this equation's relationship to the earlier ones, below is this same equation expressed using sines and cosines. Observe that the first term equals the real form of the plane wave just discussed.

$$\mathbf{u}(\mathbf{r}, t) = A_0 \cos(\mathbf{k} \cdot \mathbf{r} - \omega t + \varphi) + iA_0 \sin(\mathbf{k} \cdot \mathbf{r} - \omega t + \varphi)$$

$$\mathbf{u}(\mathbf{r}, t) = A(\mathbf{r}, t) + iA_0 \sin(\mathbf{k} \cdot \mathbf{r} - \omega t + \varphi)$$

The introduced complex form of the plane wave can be simplified by using a complex-valued amplitude  $U_0$  substitute the real valued amplitude  $A_0$ . Specifically, since the complex form...

$$\mathbf{u}(\mathbf{r}, t) = A_0 e^{i(\mathbf{k} \cdot \mathbf{r} - \omega t + \varphi)}$$

equals

$$\mathbf{u}(\mathbf{r}, t) = A_0 e^{i(\mathbf{k} \cdot \mathbf{r} - \omega t)} e^{i\varphi}$$

one can absorb the phase factor  $e^{i\phi}$  into a complex amplitude by letting  $U_0 = A_0 e^{i\phi}$ , resulting in the more compact equation

$$U(\mathbf{r}, t) = U_0 e^{i(\mathbf{k}\cdot\mathbf{r} - \omega t)}$$

While the complex form has an imaginary component, after the necessary calculations are performed in the complex plane, its real value can be extracted giving a real valued equation representing an actual plane wave.

$$\text{Re}[U(\mathbf{r}, t)] = A(\mathbf{r}, t) = A_0 \cos(\mathbf{k}\cdot\mathbf{r} - \omega t + \phi)$$

The main reason one would choose to work with complex exponential form of plane waves is that complex exponentials are often algebraically easier to handle than the trigonometric sines and cosines. Specifically, the angle-addition rules are extremely simple for exponentials.

Additionally, when using Fourier analysis techniques for waves in a lossy medium, the resulting attenuation is easier to deal with using complex Fourier coefficients. It should be noted however that if a wave is traveling through a lossy medium, the amplitude of the wave is no longer constant, and therefore the wave is strictly speaking no longer a true plane wave.

In quantum mechanics the solutions of the Schrödinger wave equation are by their very nature complex and in the simplest instance take a form identical to the complex plane wave representation above. The imaginary component in that instance however has not been introduced for the purpose of mathematical expediency but is in fact an inherent part of the “wave”.

### **Helmholtz wave equation.**

In a source-less dielectric medium,

$$\nabla \cdot \vec{D}_s = 0$$

$$\nabla \cdot \vec{B}_s = 0$$

$$\nabla \times \vec{H}_s = j\omega \vec{D}_s = j\omega \epsilon \vec{E}_s$$

$$\nabla \times \vec{E}_s = -j\omega \vec{B}_s = -j\omega \mu \vec{H}_s$$

Taking curl gives

$$\nabla \times (\nabla \times \vec{E}_s) = \nabla \times (-j\omega \mu \vec{H}_s)$$

$$\Rightarrow \nabla(\nabla \cdot \vec{E}_s) - \nabla^2 \vec{E}_s = -j\omega \mu (\nabla \times \vec{H}_s)$$

$$\Rightarrow \nabla(\nabla \cdot \vec{E}_s) - \nabla^2 \vec{E}_s = -j\omega \mu (j\omega \epsilon \vec{E}_s)$$

$$\Rightarrow \nabla^2 \vec{E}_s = \nabla(\nabla \cdot \vec{E}_s) - \omega^2 \mu \epsilon \vec{E}_s$$

$$\Rightarrow \nabla^2 \vec{E}_s = \vec{0} - \omega^2 \mu \epsilon \vec{E}_s$$

Similarly, it can be proved that

$$\nabla^2 \vec{H}_s = -\omega^2 \mu \epsilon \vec{E}_s$$

Finally, Let's Analyze the Helmholtz Wave Equation

Let's compare general wave equation (8) and Helmholtz wave equation

$$\frac{\partial^2 F_s}{\partial x^2} + \beta^2 F_s = 0 \parallel \nabla^2 \vec{E}_s + \omega \mu \epsilon \vec{E}_s$$

From the above comparison, we get,

$$\beta = \omega \sqrt{\mu \epsilon}$$

But, we already knew that

$$v = \frac{\omega}{\beta}$$

So, from the above equations, we get

$$v = \frac{1}{\sqrt{\mu \epsilon}} = \frac{1}{\sqrt{\mu_r \epsilon_r}} c$$

where c is the light velocity.

### Plane Wave Propagation in lossless medium:

In a source free lossless medium,  $\mathbf{J} = \rho = \sigma = 0$ .

Maxwell's equations:

$\mathbf{J}$  = current density  
 $\rho$  = charge density  
 $\sigma$  = conductivity

$$\nabla \times \mathbf{E} = -\mu \frac{\partial \mathbf{H}}{\partial t}$$

$$\nabla \times \mathbf{H} = \epsilon \frac{\partial \mathbf{E}}{\partial t}$$

$$\epsilon \nabla \cdot \mathbf{E} = 0$$

$$\mu \nabla \cdot \mathbf{H} = 0$$

Take the curl of the first equation and make use of the second and the third equations, we have:

Note:  
 $\nabla \times \nabla \times \mathbf{E} = \nabla(\nabla \cdot \mathbf{E}) - \nabla^2 \mathbf{E}$

$$\nabla^2 \mathbf{E} = \mu \frac{\partial}{\partial t} \nabla \times \mathbf{H} = \mu \epsilon \frac{\partial^2}{\partial t^2} \mathbf{E}$$

This is called the **wave equation**:

$$\nabla^2 \mathbf{E} - \mu \epsilon \frac{\partial^2}{\partial t^2} \mathbf{E} = 0$$

A similar equation for  $\mathbf{H}$  can be obtained:

$$\nabla^2 \mathbf{H} - \mu \epsilon \frac{\partial^2}{\partial t^2} \mathbf{H} = 0$$

In free space, the wave equation for  $\mathbf{E}$  is:

$$\nabla^2 \mathbf{E} - \mu_0 \epsilon_0 \frac{\partial^2}{\partial t^2} \mathbf{E} = 0$$

where

$$\mu_0 \epsilon_0 = \frac{1}{c^2}$$

c being the speed of light in free space ( $\sim 3 \times 10^8$  (m/s)). Hence the speed of light can be derived from Maxwell's equation.

To simplify subsequent analyses, we consider a special case in which the field (and the source) variation with time takes the form of a sinusoidal function:

$$\sin(\omega t + \phi) \quad \text{or} \quad \cos(\omega t + \phi)$$

Using complex notation, the  $\mathbf{E}$  field, for example, can be written as:

$$\mathbf{E}(x, y, z, t) = \text{Re} \left\{ \dot{\mathbf{E}}(x, y, z) e^{j\omega t} \right\}$$

where  $\dot{\mathbf{E}}(x, y, z)$  is called the **phasor form** of  $\mathbf{E}(x, y, z, t)$  and is in general a complex number depending on the spatial coordinates only. Note that the phasor form also includes the initial phase information and is a **complex number**.

Therefore differentiation or integration with respect to time can be replaced by multiplication or division of the phasor form with the factor  $j\omega$ . All other field functions and source functions can be expressed in the phasor form. As all time-harmonic functions involve the common factor  $e^{j\omega t}$  in their phasor form expressions, we can eliminate this factor when dealing with the Maxwell's equation. The wave equation can now be put in phasor form as (dropping the dot on the top, same as below):

$$\nabla^2 \mathbf{E} - \mu_0 \varepsilon_0 \frac{\partial^2}{\partial t^2} \mathbf{E} = 0 \quad \Rightarrow \quad \nabla^2 \dot{\mathbf{E}} - \mu_0 \varepsilon_0 (j\omega)^2 \dot{\mathbf{E}} = 0$$

In phasor form, Maxwell's equations can be written as:

$$\nabla \times \mathbf{E} = -j\omega \mathbf{B}$$

$$\nabla \times \mathbf{H} = j\omega \mathbf{D}$$

$$\nabla \cdot \mathbf{D} = \rho$$

$$\nabla \cdot \mathbf{B} = 0$$

Using the phasor form expression, the wave equation for  $\mathbf{E}$  field is also called the **Helmholtz's equation**, which is:

$$\nabla^2 \mathbf{E} + \mu_0 \varepsilon_0 \omega^2 \mathbf{E} = \nabla^2 \mathbf{E} + k^2 \mathbf{E} = 0$$

$$\text{where } k = \omega \sqrt{\mu_0 \varepsilon_0}$$

$k$  is called the **wavenumber** or the **propagation constant**.

$$k = k_0 = \omega \sqrt{\mu_0 \varepsilon_0} = \frac{2\pi f}{c} = \frac{2\pi}{\lambda_0}$$

where  $\lambda_0$  is the free space wavelength.

In an arbitrary medium with  $\varepsilon = \varepsilon_0 \varepsilon_r$  and  $\mu = \mu_0 \mu_r$ ,

$$k = \omega \sqrt{\mu_0 \varepsilon_0 \mu_r \varepsilon_r} = \frac{2\pi f}{c} \sqrt{\mu_r \varepsilon_r} = \frac{2\pi}{\lambda_0} \sqrt{\mu_r \varepsilon_r}$$

We call,

$$\lambda = \frac{2\pi}{k} = \frac{\lambda_0}{\sqrt{\mu_r \varepsilon_r}} = \text{wavelength in the medium}$$

In Cartesian coordinates, the Helmholtz's equation can be written as three scalar equations in terms of the respective  $x$ ,  $y$ , and  $z$  components of the  $\mathbf{E}$  field. For example, the scalar equation for the  $E_x$  component is:

$$\left( \frac{\partial^2}{\partial x^2} + \frac{\partial^2}{\partial y^2} + \frac{\partial^2}{\partial z^2} + k^2 \right) E_x = 0$$

Consider a special case of the  $E_x$  in which there is no variation of  $E_x$  in the  $x$  and  $y$  directions, i.e.,

$$\frac{\partial^2}{\partial x^2} E_x = \frac{\partial^2}{\partial y^2} E_x = 0$$

Solutions to the plane wave equation take one form of the following functions, depending on the boundary conditions:

1.  $E_x(z) = E_0^+ e^{-jkz}$
2.  $E_x(z) = E_0^- e^{+jkz}$
3.  $E_x(z) = E_0^+ e^{-jkz} + E_0^- e^{+jkz}$

$E_0^+$  and  $E_0^-$  are constants to be determined by boundary conditions.

$E_0^+ e^{-jkz}$  and  $E_0^- e^{+jkz}$  are plane waves propagating along the  $+z$  direction and  $-z$  direction.

### Plane Wave Propagation in lossy dielectric medium:

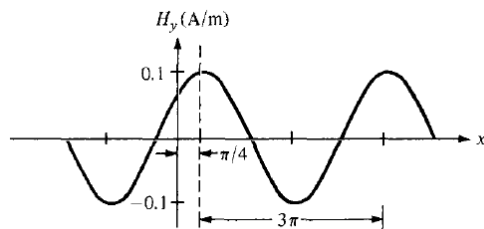

A lossy **dielectric** is a medium in which an EM wave loses power as it propagates due to poor conduction.

In other words, a lossy dielectric is a partially conducting medium (imperfect dielectric or imperfect conductor) with  $\sigma \neq 0$ , as distinct from a lossless dielectric (perfect or good dielectric) in which  $\sigma = 0$ . Consider a linear, isotropic, homogeneous, lossy dielectric medium that is charge free ( $\rho_v = 0$ ). Assuming and suppressing the time factor  $e^{j\omega t}$ , Maxwell's equations become

$$\begin{aligned}\nabla \cdot \mathbf{E}_s &= 0 \\ \nabla \cdot \mathbf{H}_s &= 0 \\ \nabla \times \mathbf{E}_s &= -j\omega\mu\mathbf{H}_s \\ \nabla \times \mathbf{H}_s &= (\sigma + j\omega\varepsilon)\mathbf{E}_s\end{aligned}$$

Taking the curl of both sides of eq

$$\nabla \times \nabla \times \mathbf{E}_s = -j\omega\mu \nabla \times \mathbf{H}_s$$

Applying the vector identity

$$\nabla \times \nabla \times \mathbf{A} = \nabla(\nabla \cdot \mathbf{A}) - \nabla^2 \mathbf{A}$$

From the above equation we get that...

$$\nabla(\nabla \cdot \mathbf{E}_s) - \nabla^2 \mathbf{E}_s = -j\omega\mu(\sigma + j\omega\varepsilon)\mathbf{E}_s$$

or

$$\nabla^2 \mathbf{E}_s - \gamma^2 \mathbf{E}_s = 0$$

where

$$\gamma^2 = j\omega\mu(\sigma + j\omega\varepsilon)$$

and  $\gamma$  is called the *propagation constant* (in per meter) of the medium. By a similar procedure, it can be shown that for the H field,

$$\begin{aligned}\nabla^2 \mathbf{H}_s - \gamma^2 \mathbf{H}_s &= 0 \\ \nabla^2 \mathbf{H}_s - \gamma^2 \mathbf{H}_s &= 0 \\ \nabla^2 \mathbf{E}_s - \gamma^2 \mathbf{E}_s &= 0\end{aligned}$$

$$\gamma^2 = j\omega\mu(\sigma + j\omega\varepsilon) \quad \gamma = \alpha + j\beta$$

We will obtain  $\alpha$  and  $\beta$  from eqs. by noting that

$$-\text{Re } \gamma^2 = \beta^2 - \alpha^2 = \omega^2\mu\varepsilon$$

and

$$|\gamma^2| = \beta^2 + \alpha^2 = \omega\mu \sqrt{\sigma^2 + \omega^2\varepsilon^2}$$

From the above equations , we obtain.

$$\alpha = \omega \sqrt{\frac{\mu\epsilon}{2} \left[ \sqrt{1 + \left[ \frac{\sigma}{\omega\epsilon} \right]^2} - 1 \right]}$$

$$\beta = \omega \sqrt{\frac{\mu\epsilon}{2} \left[ \sqrt{1 + \left[ \frac{\sigma}{\omega\epsilon} \right]^2} + 1 \right]}$$

Without loss of generality, if we assume that the wave propagates along +az and that  $E_s$  has only an x- component, then

$$\mathbf{E}_s = E_{xs}(z)\mathbf{a}_x$$

Substituting this into eq.

$$\nabla^2 \mathbf{E}_s - \gamma^2 \mathbf{E}_s = 0$$

$$(\nabla^2 - \gamma^2)E_{xs}(z)$$

Hence

$$\frac{\partial^2 E_{xs}(z)}{\partial x^2} + \frac{\partial^2 E_{xs}(z)}{\partial y^2} + \frac{\partial^2 E_{xs}(z)}{\partial z^2} - \gamma^2 E_{xs}(z) = 0$$

or

$$\left[ \frac{d^2}{dz^2} - \gamma^2 \right] E_{xs}(z) = 0$$

This is a scalar wave equation, a linear homogeneous differential equation, with solution

$$E_{xs}(z) = E_0 e^{-\gamma z} + E'_0 e^{\gamma z}$$

where  $E_0$  and  $E'_0$  are constants. The fact that the field must be finite at infinity requires that  $E'_0 = 0$ . Alternatively, because  $e^{\gamma z}$  denotes a wave traveling along  $-az$  whereas we assume wave propagation along  $az$ ,  $E'_0 = 0$ . Whichever way we look at it,  $E'_0 = 0$ . Inserting the time factor  $e^{j\omega t}$  into eq. above, we obtain

$$\mathbf{E}(z, t) = \text{Re} [E_{xs}(z)e^{j\omega t} \mathbf{a}_x] = \text{Re} (E_0 e^{-\alpha z} e^{j(\omega t - \beta z)} \mathbf{a}_x)$$

or

$$\mathbf{E}(z, t) = E_0 e^{-\alpha z} \cos(\omega t - \beta z) \mathbf{a}_x$$

A sketch of  $|\mathbf{E}|$  at times  $t = 0$  and  $t = At$  is portrayed in Figure 10.5, where it is evident that  $\mathbf{E}$  has only an x-component and it is traveling along the +z-direction. Having obtained  $\mathbf{E}(z, t)$ , we obtain  $\mathbf{H}(z, t)$  either by taking similar steps to solve eq. or by using eq. in conjunction with Maxwell's equations, We will eventually arrive at

$$\mathbf{H}(z, t) = \text{Re} (H_0 e^{-\alpha z} e^{j(\omega t - \beta z)} \mathbf{a}_y)$$

where

$$H_0 = \frac{E_0}{\eta}$$

### PLANE WAVES IN GOOD CONDUCTORS

A perfect, or good conductor, is one in which  $\sigma \gg \omega\epsilon$  so that  $\sigma / \omega\epsilon \rightarrow \infty$

$$\sigma \simeq \infty, \quad \epsilon = \epsilon_0, \quad \mu = \mu_0 \mu_r$$

Without loss of generality, if we assume that the wave propagates along +az and that  $\mathbf{E}_s$  has only an x-component, then

$$\mathbf{E}_s = E_{xs}(z) \mathbf{a}_x$$

Substituting this

$$(\nabla^2 - \gamma^2)E_{xs}(z)$$

Hence

$$\frac{\partial^2 E_{xs}(z)}{\partial x^2} + \frac{\partial^2 E_{xs}(z)}{\partial y^2} + \frac{\partial^2 E_{xs}(z)}{\partial z^2} - \gamma^2 E_{xs}(z) = 0$$

or

$$\left[ \frac{d^2}{dz^2} - \gamma^2 \right] E_{xs}(z) = 0$$

### DEPTH OF PENETRATION:

**Penetration depth** is a measure of how deep light or any electromagnetic radiation can penetrate into a material. It is defined as the depth at which the intensity of the radiation inside the material falls to  $1/e$  (about 37%) of its original value at (or more properly, just beneath) the surface.

When electromagnetic radiation is incident on the surface of a material, it may be (partly) reflected from that surface and there will be a field containing energy transmitted into the material. This electromagnetic field interacts with the atoms and electrons inside the material. Depending on the nature of the material, the electromagnetic field might travel very far into the material, or may die out very quickly. For a given material, penetration depth will generally be a function of wavelength.



According to Beer-Lambert law, the intensity of an electromagnetic wave inside a material falls off exponentially from the surface as

$$I(z) = I_0 e^{-\alpha z}$$

If  $\delta_p$  denotes the penetration depth, we have

$$\delta_p = \frac{1}{\alpha}$$

"Penetration depth" is but one term that describes the decay of electromagnetic waves inside a material. The above definition refers to the depth  $\delta_p$  at which the intensity or power of the field decays to 1/e of its surface value. In many contexts one is concentrating on the field quantities themselves: the electric and magnetic fields in the case of electromagnetic waves. Since the power of a wave in a particular medium is proportional to the *square* of a field quantity, one may speak of a penetration depth at which the magnitude of the electric (or magnetic) field has decayed to 1/e of its surface value, and at which point the *power* of the wave has thereby decreased to  $1/e^2$  or about 13% of its surface value:

$$\delta_e = \frac{1}{\alpha/2} = \frac{2}{\alpha} = 2\delta_p$$

Note that  $\delta_e$  is identical to the skin depth, the latter term usually applying to metals in reference to the decay of electrical currents (which follow the decay in the electric or magnetic field due to a plane wave incident on a bulk conductor). The attenuation constant  $\alpha/2$  is also identical to the (negative) real part of the propagation constant, which may also be referred to as  $\alpha$  using a notation inconsistent with the above use. When referencing a source one must always be careful to note whether a number such as  $\alpha$  or  $\delta$  refers to the decay of the field itself, or of the intensity (power) associated with that field. It can also be ambiguous as to whether a positive number describes attenuation (reduction of the field) or gain; this is usually obvious from the context.

The attenuation constant for an electromagnetic wave at normal incidence on a material is also proportional to the imaginary part of the material's refractive index  $n$ . Using the above definition of  $\alpha$  (based on intensity) the following relationship holds:

$$\alpha/2 = \frac{1}{\delta_e} = \frac{1}{2\delta_p} = \frac{\omega}{c} \text{Im}(\tilde{n}(\omega))$$

where  $\tilde{n}$  denotes the *complex* index of refraction,  $\omega$  is the radian frequency of the radiation, and  $c$  is the speed of light in vacuum. Note that  $\tilde{n}(\omega)$  is very much a function of frequency, as is its imaginary part which is often not mentioned (it is essentially zero for transparent dielectrics). The complex refractive index of *metals* is also infrequently mentioned but has the same significance, leading to a penetration depth (or skin depth  $\delta_e$ ) accurately given by a formula which is valid up to microwave frequencies.

Relationships between these and other ways of specifying the decay of an electromagnetic field are further detailed in the article: [Mathematical descriptions of opacity](#).

It should also be noted that we are only specifying the decay of the field which may be due to absorption of the electromagnetic energy in a lossy medium or may simply describe the penetration of the field in a medium where no loss occurs (or a combination of the two). For instance, a hypothetical substance may have a complex index of refraction  $\tilde{n} = 1 + .01j$ . A wave will enter that medium without significant reflection and will be totally absorbed in the medium with a penetration depth (in field strength) of  $\delta_e \approx 16\lambda$ , where  $\lambda$  is the vacuum wavelength. A different hypothetical material with a complex index of refraction  $\tilde{n} = 0 + .01j$  will *also* have a penetration depth of 16 wavelengths, however in this case the wave will be perfectly reflected from the material! No actual absorption of the radiation takes place, however the electric and magnetic fields extend well into the substance. In either case the penetration depth is found directly from the imaginary part of the material's refractive index as is detailed above.

### **Polarization of EM wave:**

**Polarization** (also **polarisation**) is a property of waves that can oscillate with more than one orientation. Electromagnetic waves such as light exhibit polarization, as do some other types of wave, such as gravitational waves. Sound waves in a gas or liquid do not exhibit polarization, since the oscillation is always in the direction the wave travels.

In an electromagnetic wave, both the electric field and magnetic field are oscillating but in different directions; by convention the "polarization" of light refers to the polarization of the electric field. Light which can be approximated as a plane wave in free space or in anisotropic medium propagates as a transverse wave—both the electric and magnetic fields are perpendicular to the wave's direction of travel. The oscillation of these fields may be in a single direction (linear polarization), or the field may rotate at the optical frequency (circular or elliptical polarization). In that case the direction of the fields' rotation, and thus the specified polarization, may be either clockwise or counter clockwise; this is referred to as the wave's chirality or *handedness*.

The most common optical materials (such as glass) are isotropic and simply preserve the polarization of a wave but do not differentiate between polarization states. However there are important classes of materials classified as birefringent or optically active in which this is not the case and a wave's polarization will generally be modified or will affect propagation through it. A polarizer is an optical filter that transmits only one polarization.

Polarization is an important parameter in areas of science dealing with transverse wave propagation, such as optics, seismology, radio, and microwaves. Especially impacted are technologies such as lasers, wireless and optical fiber telecommunications, and radar.

### **Linear polarization:**

In electrodynamics, **linear polarization** or **plane polarization** of electromagnetic radiation is a confinement of the electric field vector or magnetic field vector to a given plane along the direction of propagation. See polarization for more information.

The orientation of a linearly polarized electromagnetic wave is defined by the direction of the electric field vector. For example, if the electric field vector is vertical (alternately up and down as the wave travels) the radiation is said to be vertically polarized.

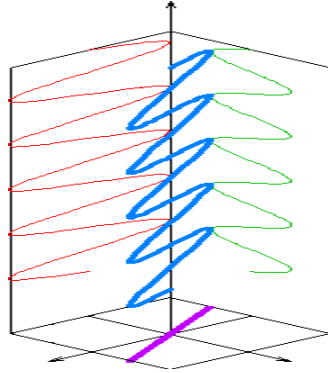

The classical sinusoidal plane wave solution of the electromagnetic wave equation for the electric and magnetic fields is (cgs units)

$$\mathbf{E}(\mathbf{r}, t) = |\mathbf{E}| \operatorname{Re} \{ |\psi\rangle \exp [i(kz - \omega t)] \}$$

$$\mathbf{B}(\mathbf{r}, t) = \hat{\mathbf{z}} \times \mathbf{E}(\mathbf{r}, t)/c$$

for the magnetic field, where  $k$  is the wavenumber,

$$\omega = ck$$

is the angular frequency of the wave, and  $c$  is the speed of light.

Here

$$|\mathbf{E}|$$

is the amplitude of the field and

$$|\psi\rangle \stackrel{\text{def}}{=} \begin{pmatrix} \psi_x \\ \psi_y \end{pmatrix} = \begin{pmatrix} \cos \theta \exp(i\alpha_x) \\ \sin \theta \exp(i\alpha_y) \end{pmatrix}$$

is the Jones vector in the x-y plane.

The wave is linearly polarized when the phase angles  $\alpha_x, \alpha_y$  are equal,

$$\alpha_x = \alpha_y \stackrel{\text{def}}{=} \alpha.$$

This represents a wave polarized at an angle  $\theta$  with respect to the x axis. In that case, the Jones vector can be written

$$|\psi\rangle = \begin{pmatrix} \cos \theta \\ \sin \theta \end{pmatrix} \exp(i\alpha).$$

The state vectors for linear polarization in x or y are special cases of this state vector.

If unit vectors are defined such that

$$|x\rangle \stackrel{\text{def}}{=} \begin{pmatrix} 1 \\ 0 \end{pmatrix}$$

and

$$|y\rangle \stackrel{\text{def}}{=} \begin{pmatrix} 0 \\ 1 \end{pmatrix}$$

then the polarization state can be written in the "x-y basis" as

$$|\psi\rangle = \cos\theta \exp(i\alpha) |x\rangle + \sin\theta \exp(i\alpha) |y\rangle = \psi_x |x\rangle + \psi_y |y\rangle$$

### Circular polarization:

**circular polarization** of an electromagnetic wave is a polarization in which the electric field of the passing wave does not change strength but only changes direction in a rotary manner.

In electrodynamics the strength and direction of an electric field is defined by what is called an electric field vector. In the case of a circularly polarized wave, as seen in the accompanying animation, the tip of the electric field vector, at a given point in space, describes a circle as time progresses. If the wave is frozen in time, the electric field vector of the wave describes a helix along the direction of propagation.

Circular polarization is a limiting case of the more general condition of elliptical polarization. The other special case is the easier-to-understand linear polarization.

The phenomenon of polarization arises as a consequence of the fact that light behaves as a two-dimensional transverse wave.

The classical sinusoidal plane wave solution of the electromagnetic wave equation for the electric and magnetic fields is

$$\begin{aligned} \mathbf{E}(\mathbf{r}, t) &= |\mathbf{E}| \operatorname{Re} \{ \mathbf{Q} |\psi\rangle \exp [i(kz - \omega t)] \} \\ \mathbf{B}(\mathbf{r}, t) &= \hat{\mathbf{z}} \times \mathbf{E}(\mathbf{r}, t) \end{aligned}$$

where  $k$  is the wavenumber,

$$\omega = ck$$

is the angular frequency of the wave,  $\mathbf{Q} = [\hat{\mathbf{x}}, \hat{\mathbf{y}}]$  is an orthogonal  $3 \times 2$  matrix whose columns span the transverse x-y plane and  $c$  is the speed of light.

Here  $|\mathbf{E}|$  is the amplitude of the field and

$$|\psi\rangle \stackrel{\text{def}}{=} \begin{pmatrix} \psi_x \\ \psi_y \end{pmatrix} = \begin{pmatrix} \cos\theta \exp(i\alpha_x) \\ \sin\theta \exp(i\alpha_y) \end{pmatrix}$$

is the Jones vector in the x-y plane.

If  $\alpha_y$  is rotated by  $\pi/2$  radians with respect to  $\alpha_x$  and the x amplitude equals the y amplitude the wave is circularly polarized. The Jones vector is

$$|\psi\rangle = \frac{1}{\sqrt{2}} \begin{pmatrix} 1 \\ \pm i \end{pmatrix} \exp(i\alpha_x)$$

where the plus sign indicates left circular polarization and the minus sign indicates right circular polarization. In the case of circular polarization, the electric field vector of constant magnitude rotates in the x-y plane.

If basis vectors are defined such that

$$|R\rangle \stackrel{\text{def}}{=} \frac{1}{\sqrt{2}} \begin{pmatrix} 1 \\ -i \end{pmatrix}$$

and

$$|L\rangle \stackrel{\text{def}}{=} \frac{1}{\sqrt{2}} \begin{pmatrix} 1 \\ i \end{pmatrix}$$

then the polarization state can be written in the "R-L basis" as

$$|\psi\rangle = \psi_R |R\rangle + \psi_L |L\rangle$$

where

$$\psi_R \stackrel{\text{def}}{=} \left( \frac{\cos \theta + i \sin \theta \exp(i\delta)}{\sqrt{2}} \right) \exp(i\alpha_x)$$

$$\psi_L \stackrel{\text{def}}{=} \left( \frac{\cos \theta - i \sin \theta \exp(i\delta)}{\sqrt{2}} \right) \exp(i\alpha_x)$$

and

$$\delta = \alpha_y - \alpha_x.$$

### Elliptical polarization:

In electrodynamics, **elliptical polarization** is the polarization of electromagnetic radiation such that the tip of the electric field vector describes an ellipse in any fixed plane intersecting, and normal to, the direction of propagation. An elliptically polarized wave may be resolved into two linearly polarized waves in phase quadrature, with their polarization planes at right angles to each other. Since the electric field can rotate clockwise or counterclockwise as it propagates, elliptically polarized waves exhibit chirality.

Other forms of polarization, such as circular and linear polarization, can be considered to be special cases of elliptical polarization.

The classical sinusoidal plane wave solution of the electromagnetic wave equation for the electric and magnetic fields is (cgs units)

$$\mathbf{E}(\mathbf{r}, t) = |\mathbf{E}| \operatorname{Re} \{ |\psi\rangle \exp [i(kz - \omega t)] \}$$

$$\mathbf{B}(\mathbf{r}, t) = \hat{\mathbf{z}} \times \mathbf{E}(\mathbf{r}, t)$$

for the magnetic field, where k is the wavenumber,

$$\omega = ck$$

is the angular frequency of the wave propagating in the +z direction, and  $c$  is the speed of light.

Here  $|\mathbf{E}|$  is the amplitude of the field and

$$|\psi\rangle \stackrel{\text{def}}{=} \begin{pmatrix} \psi_x \\ \psi_y \end{pmatrix} = \begin{pmatrix} \cos \theta \exp(i\alpha_x) \\ \sin \theta \exp(i\alpha_y) \end{pmatrix}$$

is the normalized Jones vector. This is the most complete representation of polarized electromagnetic radiation and corresponds in general to elliptical polarization.

## MODULE-IV

### RADIO WAVE PROPAGATION

#### Introduction

Radio propagation is the behavior of radio waves when they are transmitted, or propagated from one point on the Earth to another, or into various parts of the atmosphere. Radio signals are affected in many ways by objects in their path and by the media through which they travel. This means that radio signal propagation is of vital importance to anyone designing or operating a radio system. The properties of the path by which the radio signals will propagate governs the level and quality of the received signal. Reflection, refraction and diffraction may occur. The resultant signal may also be a combination of several signals that have travelled by different paths. These may add constructively or destructively, and in addition to this the signals travelling via different paths may be delayed causing distorting of the resultant signal. It is therefore very important to know the likely radio propagation characteristics that are likely to prevail.

#### Mode of Propagation

There are a number of categories into which different types of radio propagation can be placed. These relate to the effects of the media through which the signals propagate.

- ***Free space propagation:*** Here the radio signals travel in free space, or away from other objects which influence the way in which they travel. It is only the distance from the source which affects the way in which the field strength reduces. This type of radio propagation is encountered with signals travelling to and from satellites.
- ***Ground wave propagation:*** When signals travel via the ground wave they are modified by the ground or terrain over which they travel. They also tend to follow the earth's curvature. Signals heard on the medium wave band during the day use this form of propagation. Read more about Ground wave propagation
- ***Ionospheric propagation:*** Here the radio signals are modified and influenced by the action of the free electrons in the upper reaches of the earth's atmosphere called the ionosphere. This form of radio propagation is used by stations on the short wave bands for their signals to be heard around the globe. Read more about Ionospheric propagation

- **Tropospheric propagation:** Here the signals are influenced by the variations of refractive index in the troposphere just above the earth's surface. Tropospheric radio propagation is often the means by which signals at VHF and above are heard over extended distances. Read more about Tropospheric propagation

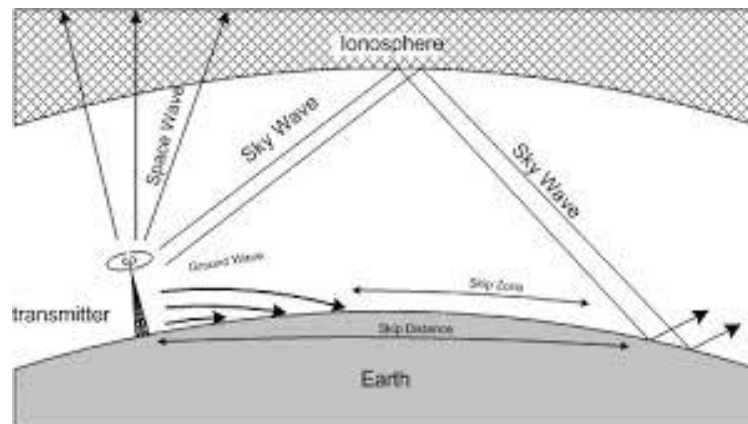

Sky Wave Propagation and Space Wave Propagation

### Layers of the Atmosphere

There are two main layers that are of interest from a radio communications viewpoint. The first is the troposphere that tends to affect radio frequencies above 30 MHz. The second is the ionosphere. This is a region which crosses over the boundaries of the meteorological layers and extends from around 60 km up to 700 km. Here the air becomes ionised, producing ions and free electrons. The free electrons affect radio communications and radio signals at certain frequencies, typically those radio frequencies below 30 MHz, often bending them back to Earth so that they can be heard over vast distances around the world.



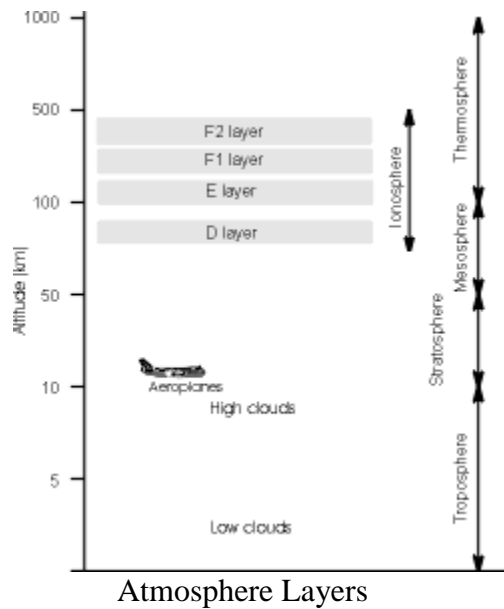

### Structure of Troposphere

The lowest of the layers of the atmosphere is the troposphere. This extends from ground level to an altitude of 10 km. It is within this region that the effects that govern our weather occur. To give an idea of the altitudes involved it is found that low clouds occur at altitudes of up to 2 km whereas medium level clouds extend to about 4 km. The highest clouds are found at altitudes up to 10 km whereas modern jet airliners fly above this at altitudes of up to 15 km.

Within the troposphere there is generally a steady fall in temperature with height and this has a distinct bearing on some radio propagation modes and radio communications that occur in this region. The fall in temperature continues in the troposphere until the tropopause is reached. This is the area where the temperature gradient levels out and then the temperature starts to rise. At this point the temperature is around  $-50^{\circ}\text{C}$ .

The refractive index of the air in the troposphere plays a dominant role in radio signal propagation and the radio communications applications that use tropospheric radiowave propagation. This depends on the temperature, pressure and humidity. When radio communications signals are affected this often occurs at altitudes up to 2 km.

### Tropospheric Scattering

**Tropospheric scatter** (also known as **troposcatter**) is a method of communicating with microwave radio signals over considerable distances – often up to 300 km, and further depending on terrain and climate factors. This method of propagation uses the tropospheric scatter phenomenon, where radio waves at particular frequencies are randomly scattered as they pass through the upper layers of the troposphere. Radio signals are transmitted in a tight beam

aimed at the highest point on the horizon in the direction of the receiver station. As the signals pass through the troposphere, some of the energy is scattered back toward the Earth, allowing the receiver station to pick up the signal.<sup>[1]</sup>

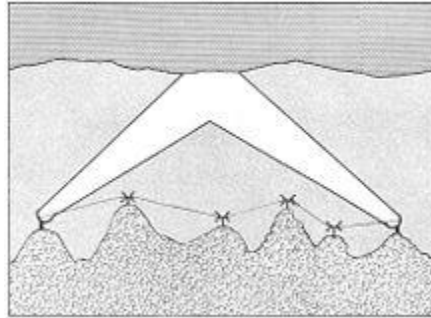

### **Tropospheric Scattering**

Normally, signals in the microwave frequency range used, around 2 GHz, travel in straight lines, and so are limited to line of sight applications, in which the receiver can be 'seen' by the transmitter. So communication distances are limited by the visual horizon to around 30-40 miles. Troposcatter allows microwave communication beyond the horizon.

Because the troposphere is turbulent and has a high proportion of moisture the tropospheric scatter radio signals are refracted and consequently only a proportion of the radio energy is collected by the receiving antennas. Frequencies of transmission around 2 GHz are best suited for tropospheric scatter systems as at this frequency the wavelength of the signal interacts well with the moist, turbulent areas of the troposphere, improving signal to noise ratios.

### **Ionosphere**

The **ionosphere** /aɪˈɒnəˌsfɪər/ is a region of Earth's upper atmosphere, from about 85 km (53 mi) to 600 km (370 mi) altitude, and includes the thermosphere and parts of the mesosphere and exosphere. It is distinguished because it is ionized by solar radiation. It plays an important part in atmospheric electricity and forms the inner edge of the magnetosphere. It has practical importance because, among other functions, it influences radio propagation to distant places on the Earth.

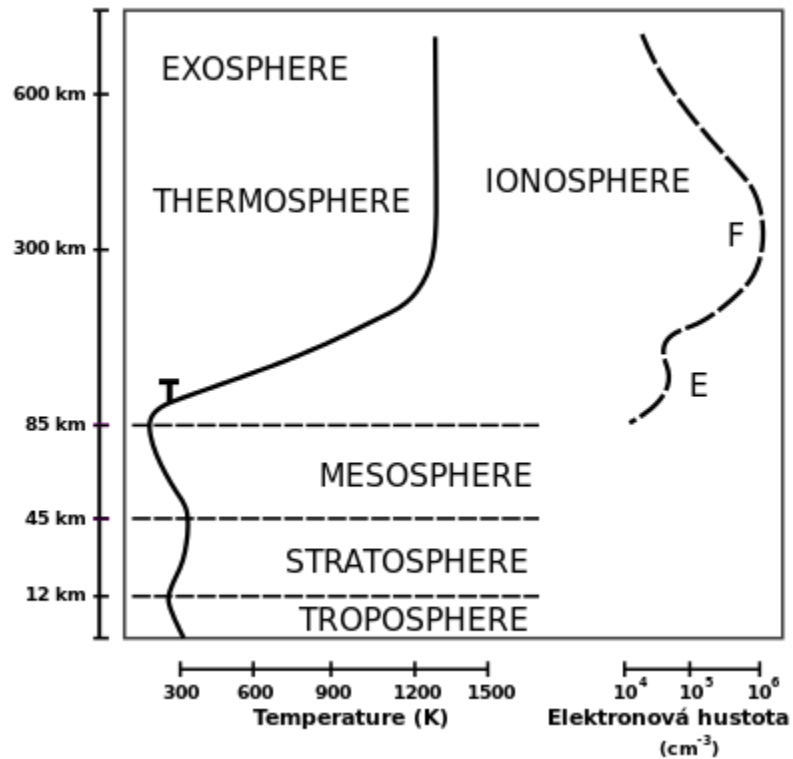

Ionization Layes

### Ionospheric Layers - D, E, F1, F2

At night the F layer is the only layer of significant ionization present, while the ionization in the E and D layers is extremely low. During the day, the D and E layers become much more heavily ionized, as does the F layer, which develops an additional, weaker region of ionisation known as the F<sub>1</sub> layer. The F<sub>2</sub> layer persists by day and night and is the region mainly responsible for the refraction of radio waves.

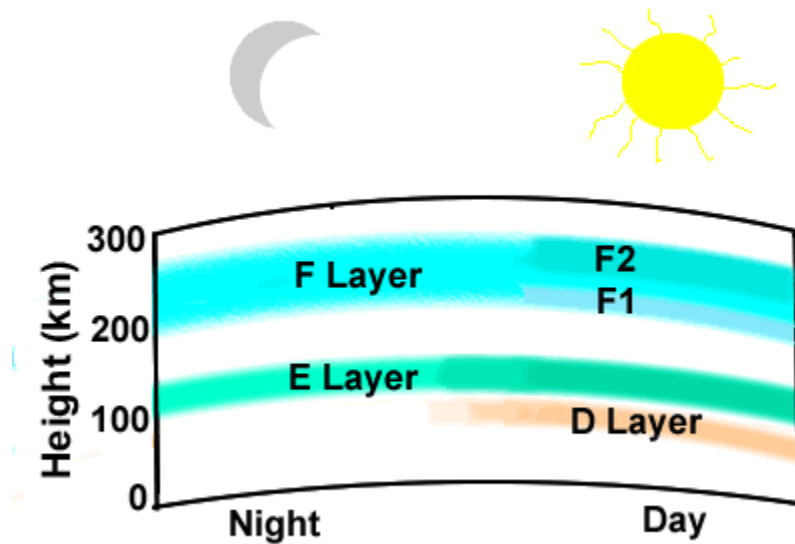

Ionization Layers during Day and Night

### D layer

The D layer is the innermost layer, 60 km (37 mi) to 90 km (56 mi) above the surface of the Earth. Ionization here is due to Lyman series-alpha hydrogen radiation at a wavelength of 121.5 nanometre (nm) ionizing nitric oxide (NO). In addition, with high Solar activity hard X-rays (wavelength < 1 nm) may ionize (N<sub>2</sub>, O<sub>2</sub>). During the night cosmic rays produce a residual amount of ionization. Recombination is high in the D layer, so the net ionization effect is low, but loss of wave energy is great due to frequent collisions of the electrons (about ten collisions every millisecond). As a result, high-frequency (HF) radio waves are not reflected by the D layer but suffer loss of energy therein. This is the main reason for absorption of HF radio waves, particularly at 10 MHz and below, with progressively smaller absorption as the frequency gets higher. The absorption is small at night and greatest about midday. The D layer reduces greatly after sunset; a small part remains due to [galactic cosmic rays]. A common example of the D layer in action is the disappearance of distant AM broadcast band stations in the daytime.

### E layer

The E layer is the middle layer, 90 km (56 mi) to 120 km (75 mi) above the surface of the Earth. Ionization is due to soft X-ray (1-10 nm) and far ultraviolet (UV) solar radiation ionization of molecular oxygen (O<sub>2</sub>). Normally, at oblique incidence, this layer can only reflect radio waves having frequencies lower than about 10 MHz and may contribute a bit to absorption on

frequencies above. However, during intense Sporadic E events, the  $E_s$  layer can reflect frequencies up to 50 MHz and higher. The vertical structure of the E layer is primarily determined by the competing effects of ionization and recombination. At night the E layer weakens because the primary source of ionization is no longer present. After sunset an increase in the height of the E layer maximum increases the range to which radio waves can travel by reflection from the layer.

### **F layer**

The F layer or region, also known as the Appleton-Barnett layer, extends from about 200 km (120 mi) to more than 500 km (310 mi) above the surface of Earth. It is the densest point of the ionosphere, which implies signals penetrating this layer will escape into space. At higher altitudes, the number of oxygen ions decreases and lighter ions such as hydrogen and helium become dominant; this layer is the topside ionosphere. There, extreme ultraviolet (UV, 10–100 nm) solar radiation ionizes atomic oxygen. The F layer consists of one layer at night, but during the day, a deformation often forms in the profile that is labeled  $F_1$ . The  $F_2$  layer remains by day and night responsible for most skywave propagation of radio waves, facilitating high frequency (HF, or shortwave) radio communications over long distances.

## **SKY WAVE PROPAGATION**

### **Introduction**

In radio communication, skywave or skip refers to the propagation of radio waves reflected or refracted back toward Earth from the ionosphere, an electrically charged layer of the upper atmosphere. Since it is not limited by the curvature of the Earth, skywave propagation can be used to communicate beyond the horizon, at intercontinental distances. It is mostly used in the shortwave frequency bands.

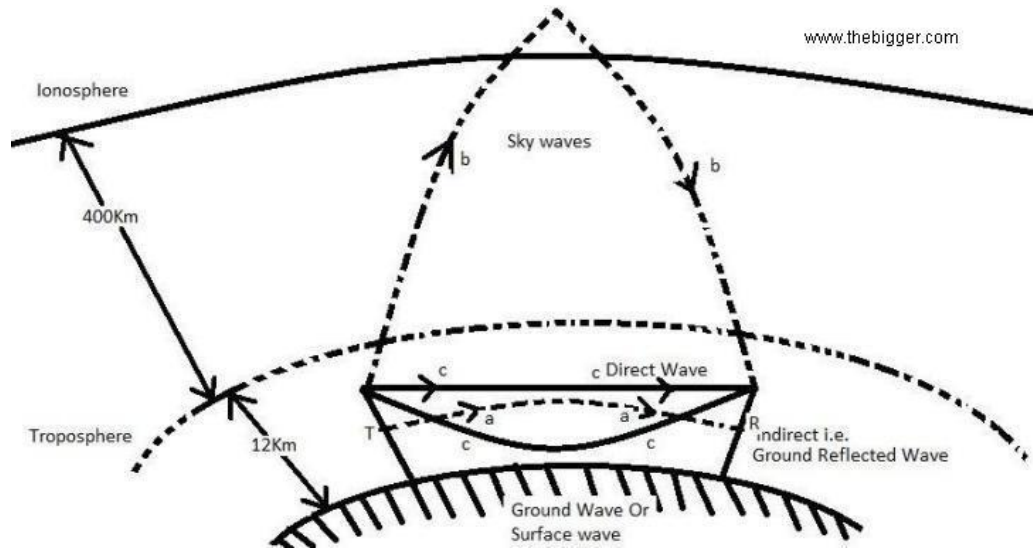

Sky Wave Propagation

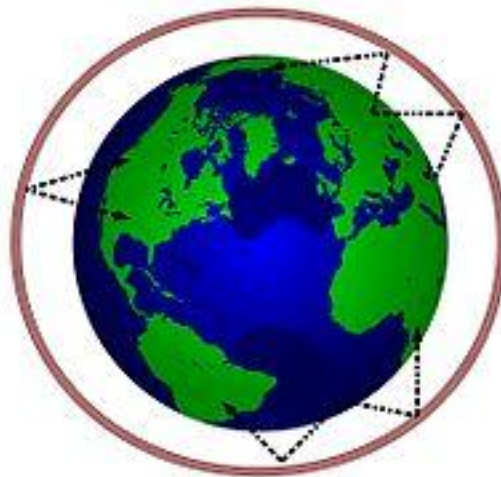

Shortwave communication through sky wave communication

### Propagation of radio waves through Ionosphere

As electromagnetic waves, and in this case, radio signals travel, they interact with objects and the media in which they travel. As they do this the radio signals can be reflected, refracted or diffracted. These interactions cause the radio signals to change direction, and to reach areas which would not be possible if the radio signals travelled in a direct line. The ionosphere is a particularly important region with regards to radio signal propagation and radio communications in general. Its properties govern the ways in which radio communications, particularly in the HF radio communications bands take place.

The ionosphere is a region of the upper atmosphere where there are large concentrations of free ions and electrons. While the ions give the ionosphere its name, but it is the free electrons that affect the radio waves and radio communications. In particular the ionosphere is widely known

for affecting signals on the short wave radio bands where it "reflects" signals enabling these radio communications signals to be heard over vast distances. Radio stations have long used the properties of the ionosphere to enable them to provide worldwide radio communications coverage. Although today, satellites are widely used, HF radio communications using the ionosphere still plays a major role in providing worldwide radio coverage. The free electrons do not appear over the whole of the atmosphere. Instead it is found that the number of free electrons starts to rise at altitudes of approximately 30 km. However it is not until altitudes of around 60 to 90 kilometres are reached that the concentration is sufficiently high to start to have a noticeable effect on radio signals and hence on radio communications systems. It is at this level that the ionosphere can be said to start.

The ionisation in the ionosphere is caused mainly by radiation from the Sun. In addition to this, the very high temperatures and the low pressure result in the gases in the upper reaches of the atmosphere existing mainly in a monatomic form rather than existing as molecules. At lower altitudes, the gases are in the normal molecular form, but as the altitude increases the monatomic forms are more in abundance, and at altitudes of around 150 kilometres, most of the gases are in a monatomic form. This is very important because it is found that the monatomic forms of the gases are very much easier to ionise than the molecular forms.

### **Effect of earth's magnetic field**

As an ionized medium, the ionosphere plays a special role in radio wave propagation. The Martian ionosphere differs from Earth's in a number of ways. Due to the greater distance from the Sun at Mars than Earth, the weaker solar radiation flux generates a lower plasma density in the Martian ionosphere. While Earth's ionosphere has four layers, the Martian ionosphere is a single layer of ionized gas that extends from about 100 kilometers to several hundred kilometers above the surface, as shown in Figure 2.2-1 from Viking Lander 2 direct measurements. Earth's ionosphere is shielded from the solar wind by a strong planetary magnetic field. In contrast, the Mars ionosphere is directly exposed to the solar wind because Mars lacks a strong magnetic field. Presence of a magnetic field can influence the plasma motion within the ionosphere and also affect low frequency radio wave propagation.

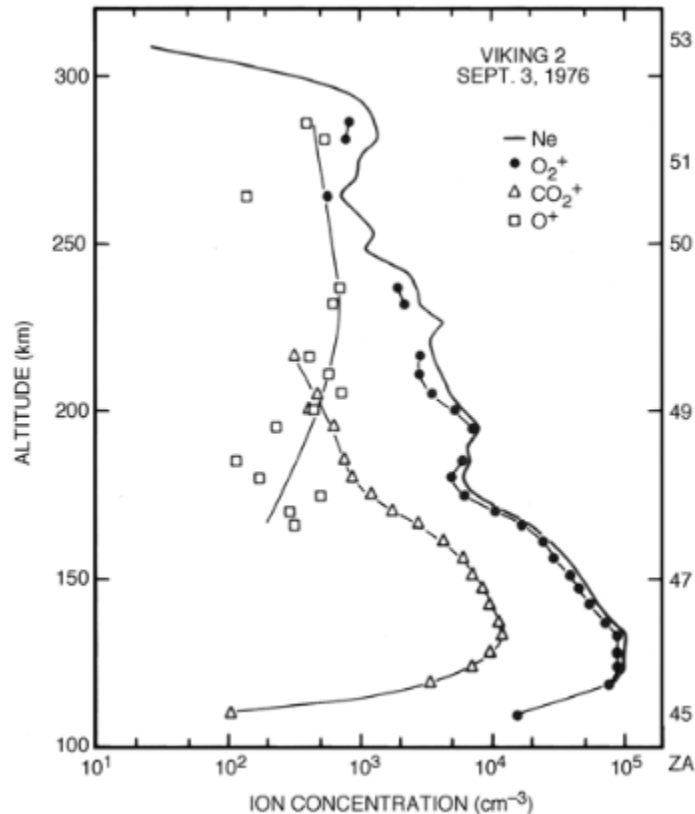

### A Martian Ionospheric Altitude Profile of Electron Density

Previous missions made inconclusive measurements of the Martian magnetic field. The weak magnetic field ( $< 100$  nT) measured by the previous missions had been interpreted as the evidence for a Martian magnetic field, although argued that the measurements could be better explained in terms of a draped interplanetary magnetic field (IMF). Recent measurements by the Mars Global Surveyor (MGS) mission have confirmed that there is no intrinsic dipole magnetic field in Mars. The MGS magnetometer discovered that the Martian magnetic field is very weak compared to that of Earth's magnetic field, only  $1/800$  the strength. The weak magnetic field is probably generated by a diffused draping IMF. The solar wind rams into the Martian ionosphere and generates complicated magnetic fields. Thus, this region may have a complicated interaction with the Martian magnetosphere.

### Virtual height

Since the ionosphere have different types of layers namely D,E and F layers. So when a pulse transmitted from transmitter it get deflected or we can say reflect by these different layers and reaches to the receiver. Thus the path followed by the pulse is the *Actual path*. The distance between the highest point of actual path and the earth surface is called *Actual*



*height*. When a short pulse of energy sent vertically upward and traveling with the speed of light would reach taking the same two rays travel time as does the actual pulse reflected from the ionospheric layers. that height is known as **Virtual height of an antenna**.

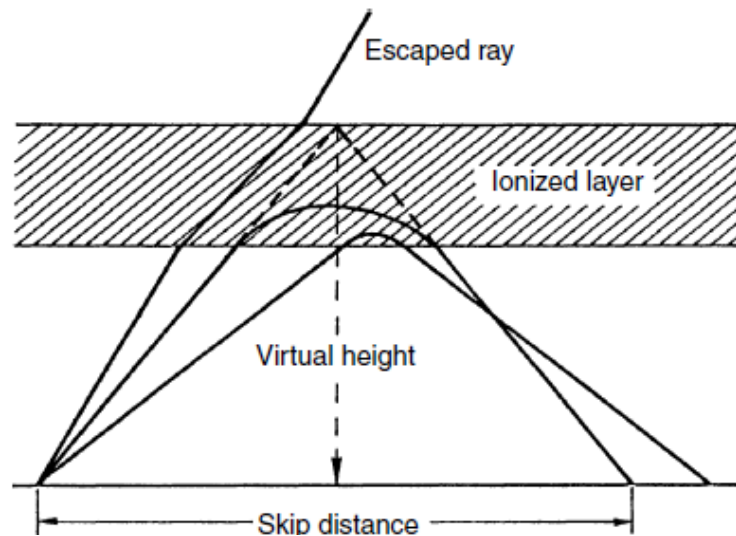

Virtual Height

### **Skip Distance**

A **skip distance** is the distance a radio wave travels, usually including a hop in the ionosphere. A skip distance is a distance on the Earth's surface between the two points where radio waves from a transmitter, refracted downwards by different layers of the ionosphere, fall. It also represents how far a radio wave has travelled per hop on the Earth's surface, for radio waves such as the short wave (SW) radio signals that employ continuous reflections for transmission.

Radio waves from a particular transmitting antenna do not all get refracted by a particular layer of the ionosphere; some are absorbed, some refracted while a portion escapes to the next layer. At this higher layer, there is a possibility of this radio wave being bent downwards to earth again. This bending happens because each layer of the ionosphere has a refractive index that varies from that of the others.<sup>[2]</sup> Because of the differing heights of refraction, or apparent reflection, the radio waves hit the earth surface at different points hence generating the skip distance.

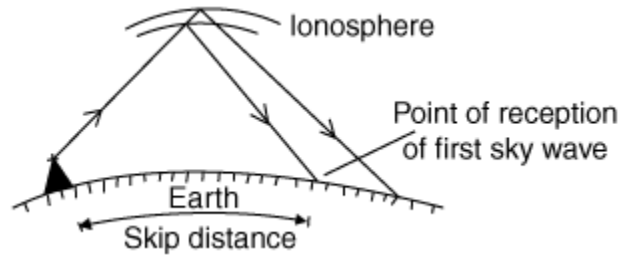

Skip distance for space wave propagation

### Critical frequency

In telecommunication, the term **critical frequency** has the following meanings:

- In radio propagation by way of the ionosphere, the limiting frequency at or below which a wave component is reflected by, and above which it penetrates through, an ionospheric layer.
- At near vertical incidence, the limiting frequency at or below which incidence, the wave component is reflected by, and above which it penetrates through, an ionospheric layer.

Critical Frequency changes with time of day, atmospheric conditions and angle of fire of the radio waves by antenna.

The existence of the critical frequency is the result of electron limitation, *i.e.*, the inadequacy of the existing number of free electrons to support reflection at higher frequencies.

When the refractive index,  $n$  has decreased to the point where  $n = \sin \phi_i$ , where  $\phi$  is *the* angle of refraction  $f$  will be  $90^\circ$  and wave will be travelling horizontally. The higher point reached by the wave is free. The electron density  $N$  at the that point satisfies the relation

$$n = \frac{\sin \phi_i}{\sin \phi_r} = \frac{\sin \phi_i}{\sin 90} = \sin \phi_i = \sqrt{1 - \frac{81N \max}{f_{muf}^2}} \quad \dots (1)$$

$$f_c^2 = 81N \max \quad \dots (2)$$

Where  $f_c$  is the critical frequency

### (Maximum Usable Frequency) MUF

In radio transmission **maximum usable frequency (MUF)** is the highest radio frequency that can be used for transmission between two points via reflection from the ionosphere (skywave or "skip" propagation) at a specified time, independent of transmitter power. This index is especially useful in regard to shortwave transmissions. In shortwave radio communication, a major mode of long distance propagation is for the radio waves to reflect off the ionized layers of

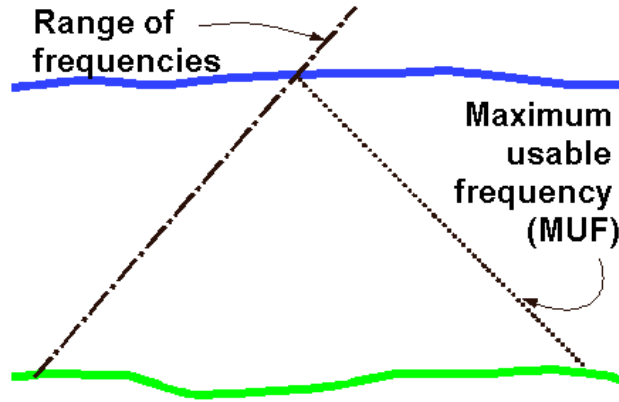

### Maximum Usable Frequency

the atmosphere and return diagonally back to Earth. In this way radio waves can travel beyond the horizon, around the curve of the Earth. However the refractive index of the ionosphere decreases with increasing frequency, so there is an upper limit to the frequency which can be used. Above this frequency the radio waves are not reflected by the ionosphere but are transmitted through it into space.

$$\text{MUF} = \frac{\text{critical frequency}}{\cos \theta} \quad \dots(3)$$

$$f_{muf}^2 = \frac{f_c^2}{\cos^2 \phi i} = f_c^2 \sec^2 \phi i \quad \dots (4)$$

$$f_{muf} = f_c \sec^2 \phi i$$

The above equation is known as secant law, it indicates that  $f_{muf}$  is greater than critical frequency by a factor of  $\sec \phi$ . It gives the frequency which can be used for sky wave propagation for given angle of incidence between two locations.

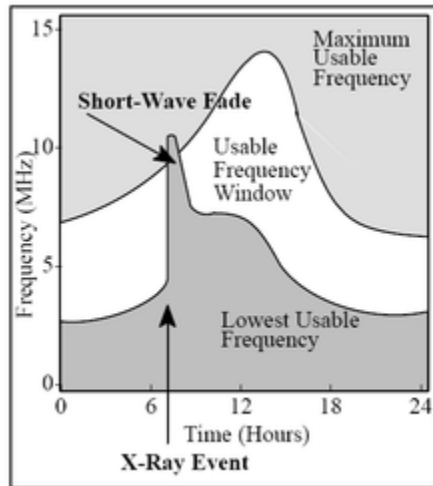

Maximum Usable Frequency at different day and night time

## SPACE WAVE PROPAGATION

**Introduction:** The radio waves having high frequencies are basically called as space waves. These waves have the ability to propagate through atmosphere, from transmitter antenna to receiver antenna. These waves can travel directly or can travel after reflecting from earth's surface to the troposphere surface of earth. So, it is also called as Tropospherical Propagation. In the diagram of medium wave propagation, c shows the space wave propagation. Basically the technique of space wave propagation is used in bands having very high frequencies. E.g. V.H.F. band, U.H.F band etc. At such higher frequencies the other wave propagation techniques like sky wave propagation, ground wave propagation can't work. Only space wave propagation is left which can handle frequency waves of higher frequencies. The other name of space wave propagation is line of sight propagation. There are some limitations of space wave propagation.

1. These waves are limited to the curvature of the earth.
2. These waves have line of sight propagation, means their propagation is along the line of sight distance.

The line of sight distance is that exact distance at which both the sender and receiver antenna are in sight of each other. So, from the above line it is clear that if we want to increase the transmission distance then this can be done by simply extending the heights of both the sender as well as the receiver antenna. This type of propagation is used basically in radar and television communication.

The frequency range for television signals is nearly 80 to 200MHz. These waves are not reflected by the ionosphere of the earth. The property of following the earth's curvature is also missing in these waves. So, for the propagation of television signal, geostationary satellites are used. The satellites complete the task of reflecting television signals towards earth. If we need greater transmission then we have to build extremely tall antennas.

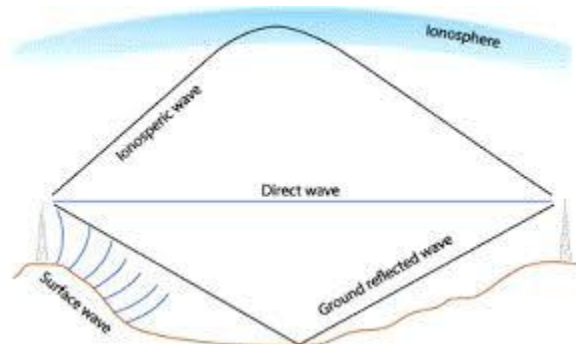

### **Space wave Communication**

Space Waves, also known as direct waves, are radio waves that travel directly from the transmitting antenna to the receiving antenna. In order for this to occur, the two antennas must be able to “see” each other; that is there must be a line of sight path between them. The diagram on the next page shows a typical line of sight. The maximum line of sight distance between two antennas depends on the height of each antenna.

Generally, space waves are “line of sight” receivable, but those of lower frequencies will “bend” over the horizon somewhat. Since the VOR signal at 108 to 118 MHz is a lower frequency than distance measuring equipment (DME) at 962 to 1213 MHz, when an aircraft is flown “over the horizon” from a VOR/DME station, the DME will normally be the first to stop functioning.